



PELLET STOVE

DUO HYDRO-AIR

PART 2 - OPERATION AND CLEANING

Instructions in English

MCZ

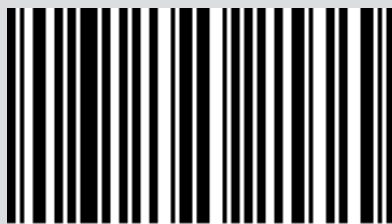

8901505600

TABLE OF CONTENTS

TABLE OF CONTENTS	II
7-PRECAUTIONS BEFORE START-UP	3
8-CONTROL PANEL	4
9-FIRST START-UP	5
10-MENU STRUCTURE	8
11-INFORMATION MENU	12
12-SETTINGS MENU	15
13-TECHNICAL MENU	33
14-SAFETY DEVICES AND ALARMS	34
15-RECOMMENDATIONS FOR A SAFE USE	39
16-CLEANING AND MAINTENANCE	40
17-FAULTS/CAUSES/SOLUTIONS	47
18-CIRCUIT BOARD	50

7-PRECAUTIONS BEFORE START-UP

GENERAL PRECAUTIONS

Remove any objects that may burn from the brazier (manual, various adhesive labels or any polystyrene).

Check that the brazier is positioned correctly and rests properly on the base.



The first start-up may not be successful as the feed screw is empty and does not always manage to load the required amount of pellets in time to light the flame.



CANCEL THE FAILED IGNITION ALARM. REMOVE THE PELLETS LEFT IN THE BRAZIER AND REPEAT THE START-UP.

If after repeated attempts, the flame fails to ignite, despite a regular flow of pellets in the brazier, which **must rest snugly against the slots and be clean without any ash incrustations**. If no anomaly is found during this inspection, there may be a problem with the product components or installation may not be correct.



REMOVE THE PELLETS FROM THE BRAZIER AND CONTACT AN AUTHORISED TECHNICIAN.



Do not touch the boiler during the first lighting, as it is during this phase that the paint sets. If you touch the paint, you may expose the steel surface.

If necessary, touch up the paint with the spray can of the specific colour. (See "Pellet stove accessories").



It is good practice to ensure effective ventilation in the room during the initial start-up, as the boiler will emit some smoke and smell of paint.



ATTENTION!

Please ensure the brazier is clear of ALL pellets and ash build up following any failed ignitions. Failure to clear out the brazier prior to resetting may result in further failed ignitions or in certain conditions an explosive ignition.

Do not stand close to the stove and, as mentioned, air the room. The smoke and smell of paint will disappear after about an hour of operation, however, they are not harmful in any case.

The boiler will be subject to expansion and contraction during the lighting and cooling down stages, and may therefore make slight creaking noises.

This is absolutely normal as the structure is made of laminated steel and must not be considered a defect.

It is extremely important to make sure the boiler does not reach high temperatures straight away, but to increase the temperature gradually using low power at first.

This will prevent damaging the ceramic or serpentine stone tiles, the welds and the steel structure.



DO NOT EXPECT HEATING EFFICIENCY IMMEDIATELY!!!

ATTENTION!

If during operation or initial ignition you encounter smoke spillage in to the room from the appliance or the flue then please switch off the appliance, ventilate the room and contact the installation / service engineer immediately.

8-CONTROL PANEL

CONTROL PANEL DISPLAY

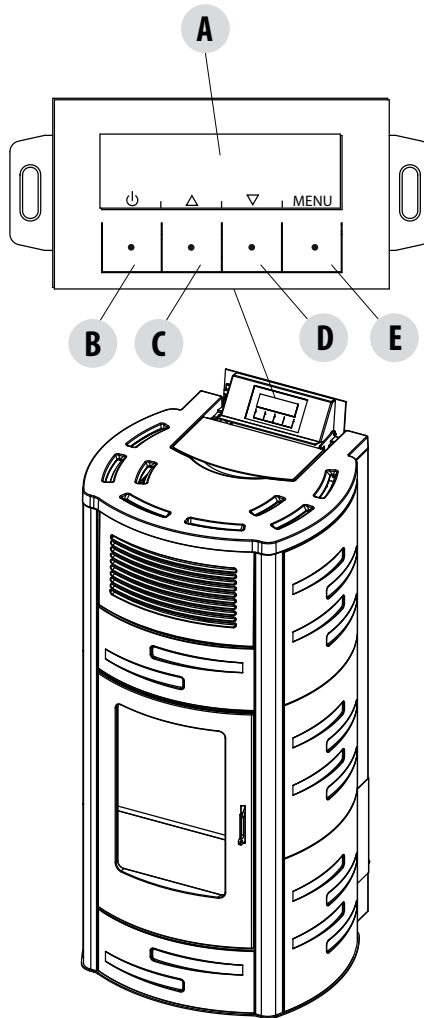

KEY

A - DISPLAY; indicates a series of information on the stove, as well as the identification code of any malfunction.

B - Function selection key indicated by the upper display (i.e. start-up/shutdown)

C - Function selection key indicated by the upper display (i.e. increase/scrolling)

D - Function selection key indicated by the upper display (i.e. decrease/scrolling)

E - Function selection key indicated by the upper display (i.e. menu)

9-FIRST START-UP

INITIAL START-UP

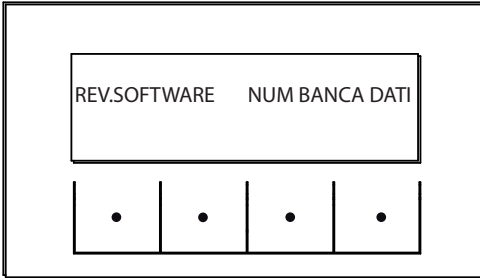

At initial start-up, after connecting the power cable and pressing the I/O button, the stove display will show wording for the software version and database number (after a few seconds it will move on to the next screen).

If the language has already been set, the next screen will be OFF, otherwise one enters the following parameter.

SELECT LANGUAGE

At initial start-up, if it has never been set, the LANGUAGE choice screen appears.

The system displays all possible languages.

Using the arrow keys (C, D) scroll the languages and confirm the desired language using the "E" (OK) key.

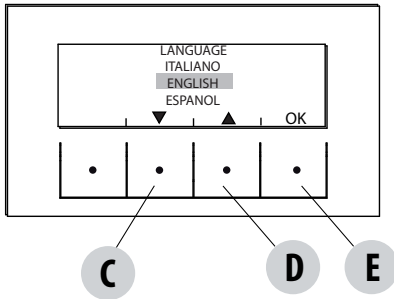

SETTING TIME AND DAY

The keys that are active for this function: "C", "D", "E". The C-D keys are used to choose time or day while the E key is used to confirm.

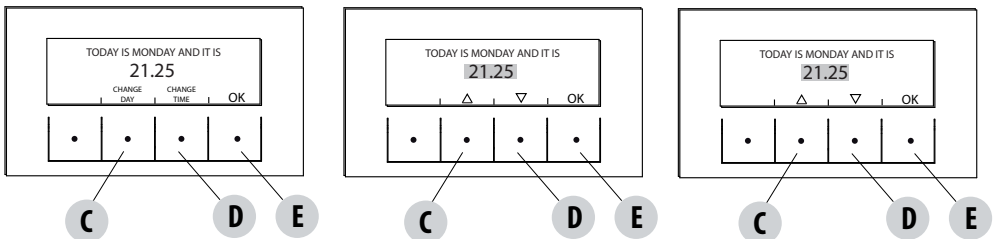

9-FIRST START-UP

SCREEN OFF

If a LANGUAGE has already been set, the display will go to OFF.

Pressing any one of the keys (B, C, D, E) will result in the first screen showing OFF to be displayed. From this screen, pressing keys "B" and "E" (respectively corresponding to ON and MENU) it is possible to access the panel or the menu. If no key is pressed, the display will once again show OFF after 5 seconds.

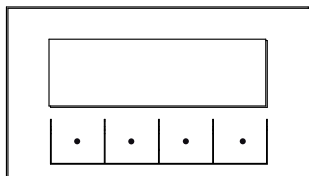

OFF-DISPLAY OFF

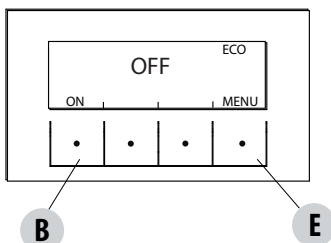

OFF-DISPLAY ACTIVE

PRELIMINARY OPTIONS

Hydro Air stoves are characterised by the presence of a heating hydraulic circuit and a room air fan for distributing hot air.

The possibility of deviating the hydraulic circuit towards a finned copper exchanger based on user request or automatically to double the amount of heat distributed to the room air (also see HYDRO AIR SETTINGS MENU).

Room fan

The speed can be set manually or automatically.

In manual mode the speed, from 0 to 5, is chosen by the user from the control panel. The fan is only activated if the air output temperature exceeds 42°C and is deactivated when it goes below 40°C; while at speed 0 the fan is off.

In automatic the stove adjusts fan speed in order to obtain stable output air temperature (approximately 55°C in Hydro Air On mode and

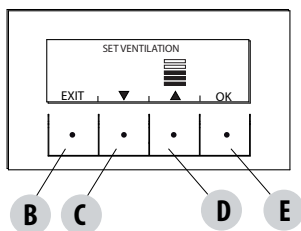

45°C in Hydro Air Off mode), optimising acoustic comfort with an equal power provided. Even in this case the fan is only activated if air temperature exceeds 42°C.

For greater comfort, maximum fan speed in automatic mode corresponds to 3 and shuts off only if the temperature falls below 40°C.

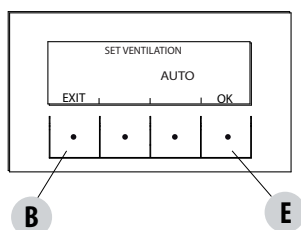

9-FIRST START-UP

Lighting the stove

To switch on the stove, keep the "B" (ON) key on the panel pressed. The stove starts an ignition procedure that brings the flame to a suitable level to Supply Power.

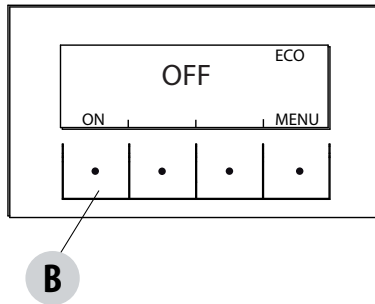

Supplying power

The stove's power supply is signalled by "power level bars": one bar corresponds to minimum power, 5 bars to maximum power, this level is determined by the heating system heat requirements, the stove adjusts pellet loading parameters, fumes extraction and combustion air flow to comply with this requirement.

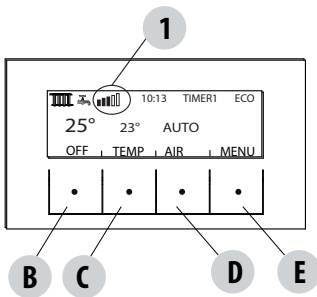

TOP BAR: active requirements, active programs, power bar, functions

CENTRAL BAR: room temperature, room set, room fan bar

BOTTOM BAR/KEYS: shut-off "B", temperature set modify "C" and fan set "D", menu "E"

1 = power level bars

10-MENU STRUCTURE

MENU STRUCTURE

To enter MENU press the "E" key (MENU).

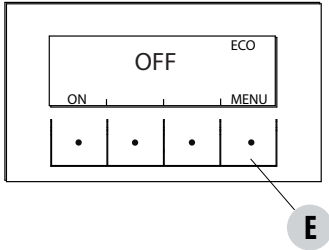

Next, this screen with the following functions is displayed:

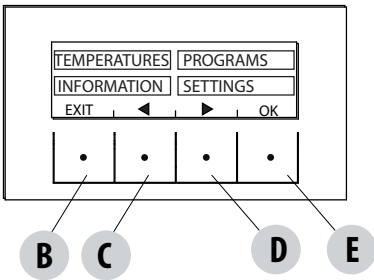

Sub-menu
TEMPERATURE
PROGRAMMES
INFORMATION
SETTINGS

TEMPERATURE (hydro air)

When accessing this function, the main screen makes it possible to set heating and sanitary water temperature (if boiler with probe configured - see menu settings input aux).

Select what is to be set and then using the C and D keys increase/decrease the temperature, use the E key to confirm while the B key is used to exit and return to the main MENU.

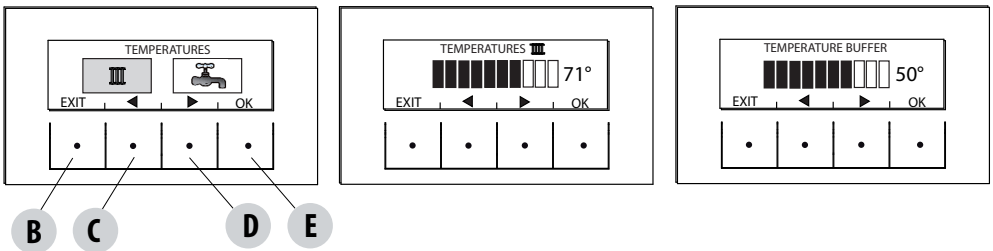

PROGRAMMES

In this case it is possible to choose the programme to be set.

Programme selection makes it possible to choose between one of the following options (one choice excludes the other):

- TIMER 1
- TIMER 2
- MANUAL
- TEMP. LEVELS
- SLEEP FUNCT.

10-MENU STRUCTURE

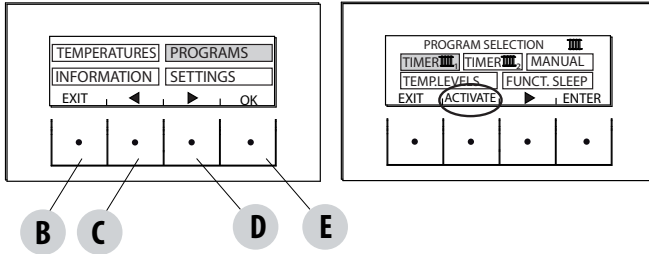

In the MENU screen, move the cursor with arrows "C"- "D" and select PROGRAMS, press ok "E" to confirm. Next select the programme you wish to set.

Once completed, always press "ACTIVATE" to confirm the choice of programme.

The TIMER 1 and 2 programmes are freely programmable for each 1/2 hour of the day on three different temperature indicators (T1-T2-T3) and in different ways for each day of the week. The OFF level requires that the stove is switched off in that interval.

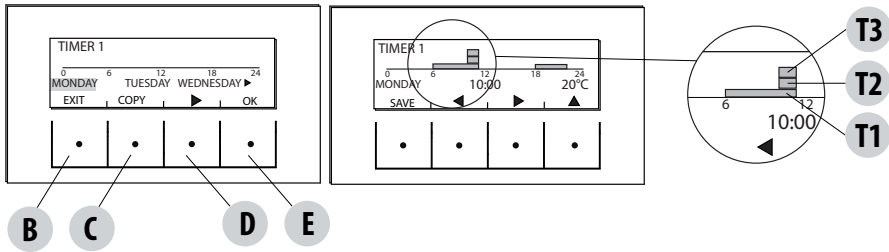

Example of temperature programming for Monday.

Select the TIMER 1 item from the PROGRAM menu and press the ENTRA (ENTER) "E" key, using arrow "D" highlight Monday and press OK ("E") to enter programming.

Using the centre arrow keys "C" and "D" select the half hour interval to be selected and use the "E" key to set temperature T1-T2-T3 (depending on whether the key is pressed 1-2-3 times the corresponding temperature can be read in the bottom right of the display). Once temperature programming for Monday is complete press the "B" SALVA (SAVE) key. If the same temperature scale of Monday is desired for other week days, after saving ("E" key) press the "C" key (COPIA-COPY), select the day where the program is to be copied using the "D" key and press the "C" key (INCOLLA-PASTE). Repeat the same procedure until the programmes for all the days of the week are complete. At this point the stove is programmed according to your temperature needs, which can be modified at any time.

CAUTION:

In order to make stove use easier, MCZ supplies Timer 1 with preset weekly temperatures and times (according to the table below), while Timer 2 is available. In any case, it is possible to change times and temperatures of Timer 1 at any time.

PANEL OFF DISPLAY FROM TIMER

When timer 1 (for example) has no set temperature, the panel highlights that the stove is in OFF position.

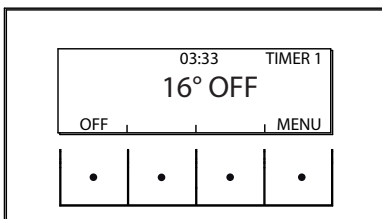

If the stove is off by MANUAL command, the timer will have no effect.

For the stove to come on with the timer, the panel must display the image shown on the side; if this should not be the case, it may be necessary to press the ON ("B") key.

10-MENU STRUCTURE

Weekly programmes		Time table																							
		Temperatures*																							
Days		T3	T2	T1	OFF	T3	T2	T1	OFF	T3	T2	T1	OFF	T3	T2	T1	OFF	T3	T2	T1	OFF	T3	T2	T1	OFF
Sunday																									
Monday																									
Tuesday																									
Wednesday																									
Thursday																									
Friday																									
Saturday																									

* T1=16°C T2=20°C T3=22°C OFF=switched off

10-MENU STRUCTURE

MANUAL

This function can be activated from the menu PROGRAMME by pressing the key "C" ACTIVE. When this function is activated the stove no longer follows time programming of TIMER 1 or 2 programmes, but it keeps the temperature set in the main screen throughout the 24 hour time period. It is possible to switch to programmes at any time.

TEMPERATURE LEVELS

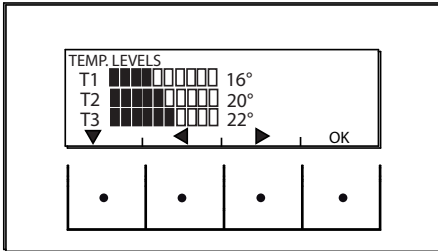

It is possible to change the 3 temperature levels referenced by timers in this menu.

From the PROGRAMS menu use arrow key "D" to move and select TEMP LEVELS, press the "E" keys and enter the temperature settings screen. With the centre arrow keys "C" and "D" increases/decreases the temperature value, while the "B" is used to move to the next temperature. With the "E" key (OK) the set values are confirmed.

SLEEP FUNCTION

The sleep is only activated when the stove supplies power and makes it possible to programme a stove shut off time. The shut off can be delayed for a maximum of 8 hours from current time and with a 10 minute resolution.

To activate, enter the PROGRAM menu, scroll using arrow key "D" up to the Function. SLEEP press the ATTIVA (ACTIVATE) "C" key. In the next screen, using keys "C" and "D", increase or decrease the minutes (10 minutes each time the key is pressed) and press OK ("E" key) to confirm the stove shut off time.

NOTE: If the stove is not supplying power the display shows the wording "NOT AVAILABLE".

11-INFORMATION MENU

INFORMATION

To enter the menu INFORMATION proceed as follows:

from the main/initial screen, press the "E" Menu button, scroll using the "D" arrow key, up to the Information item, press the "E" ok key, scroll again using the "D" arrow key up to software/data memory/all.memory/stove state and select the desired item, press OK using the "E" key to enter the chosen information menu.

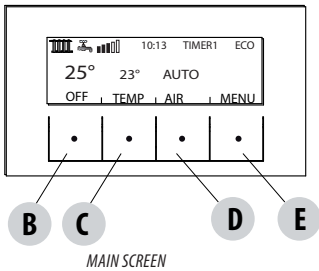
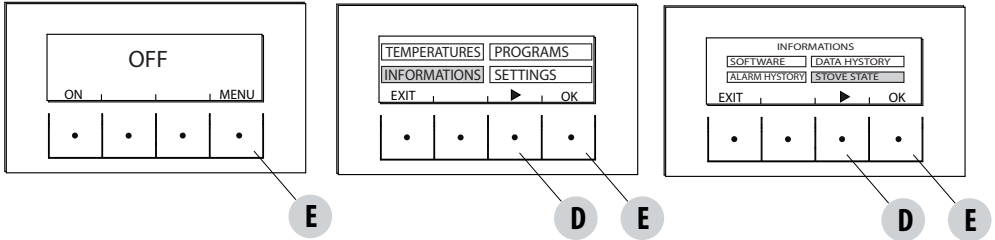

The available information is:

- Software
- Data memory
- All. memory
- Stove state

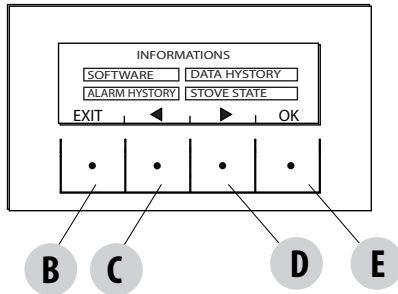

SOFTWARE INFORMATION

The available data in this function are:

- CODE
- FIRMWARE
- DATABASE
- INTERFACE

It is information that can be used to identify the electronic part of the stove.

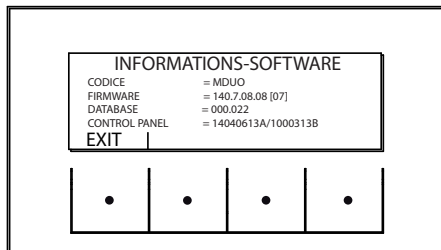

EXAMPLE

11-INFORMATION MENU

DATA MEMORY-INFORMATION

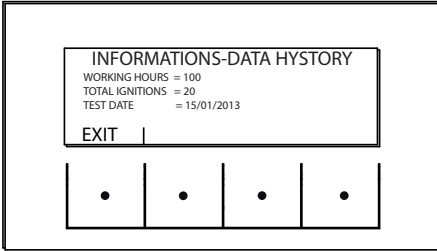

The available data in this function are:
WORKING HOURS
TOTAL IGNITIONS
TEST DATE

ALARM MEMORY-INFORMATION

It gives information about the last alarms detected.

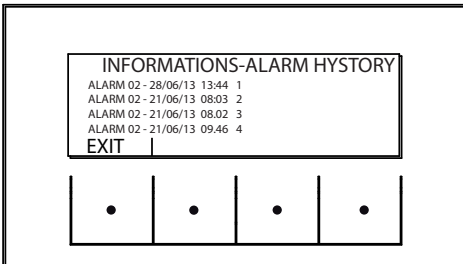

11-INFORMATION MENU

STOVE STATE-INFORMATION

This menu is particularly useful if one wants to verify the stove work condition (State).

From the OFF screen, press the "E" Menu button, scroll with the "D" arrow key, up to the Information item, press the ok "E" key, scroll again with the "D" arrow key up to stove state, press OK with the "E" key and one enters the stove State-information menu.

The items available within STOVE-STATE INFORMATION can be viewed using the "C" and "D" arrow keys and are:

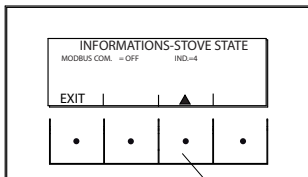
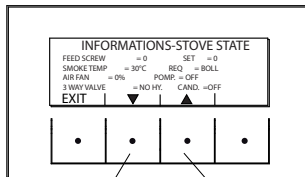
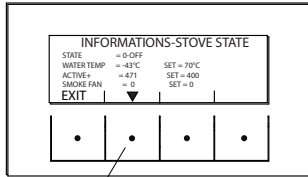

<i>state</i>	
<i>water temp.</i>	<i>set</i>
<i>aux sensor</i>	<i>set</i>
<i>active+</i>	<i>set</i>
<i>fumes fan</i>	<i>set</i>
<i>auger</i>	<i>set</i>
<i>fumes temp.</i>	<i>req</i>
<i>air fan</i>	<i>pump</i>
<i>relay aux</i>	<i>spark plug</i>
<i>modbus com</i>	<i>add.</i>

- The main stove states that can be read on the display are:

STATE 1-9 various ignition phases
 STATE 20-40 work state (power supply)
 STATE 60-79 alarm state
 STATE 80-84 shut off/cooling/autoeco state
 STATE 85-93 auxiliary functions
 STATE 94-95 cleaning state

- WATER TEMP.: Water temperature detected by the probe inside the stove and related SET
- AUX SENSOR: detects the value measured by the aux sensor (external/boiler/puffer)
- ACTIVE+.: Value read by the Active Plus system and related SET
- FAN FUMES: Number of fumes fan revolutions and related SET
- AUGER: Number of auger revolutions and related SET
- FUMES TEMP: fumes temperature value read by the probe inside the stove
- REQ: (Heating/Sanitary) signals if system requires heat
- AIR FAN: Room fan operation level
- PUMP: signals if the stove's internal pump is turned on (ON) or turned off (OFF)
- RELAY AUX: signals activation (ON) or the OFF state of Auxa relay
- SPARK PLUG: Signals if spark plug is turned on or off
- MODBUS COM: External interface communication state
- ADD.: Address for communicating with modbus

12-SETTINGS MENU

SETTINGS

To enter the menu SETTINGS proceed as follows:

from the OFF screen , press the "E" Menu key, scroll with the "D" arrow key, up to the Settings item, press the ok "E" key, scroll again with the "D" and/or "C" arrow key up to the chosen setting, press OK with the "E" key to enter the chosen menu.

It is possible to set the listed parameters from this screen. Each parameter has an info key to obtain brief information about the chosen function.

- SETTINGS

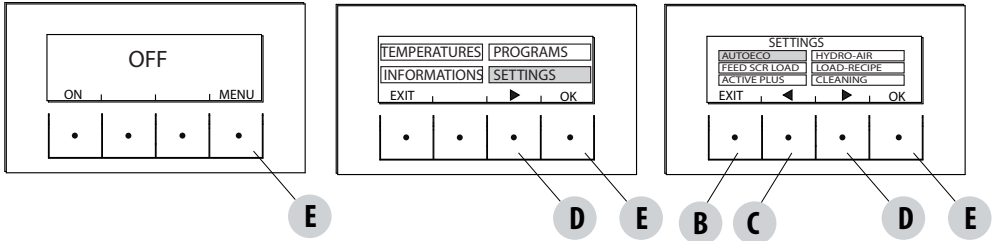

- Auto Eco (default activated)
- Hydro Air
- Auger loading
- Pellet recipe
- Active +
- Cleaning cycle
- Language
- date - time
- Aux Input
- aux output
- Room Input
- T. on Pump
- Pump Pwm
- Antifreeze function
- Plt sensor (not available)
- Modbus com.
- Display
- Technical menu (accessible by a specialized MCZ technician - password required)
 - Active +
 - Fume Analysis F
 - Calib.Active
 - Calib.S.fumes
 - Diagnostics
 - Parameters
 - Boll advance
 - Hour reset

12-SETTINGS MENU

AUTOECO (Factory activated)

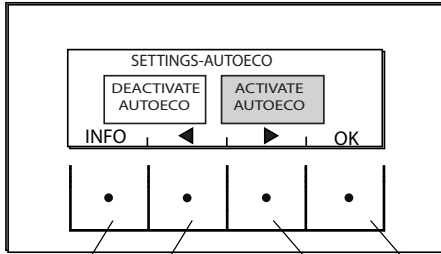

B **C** **D** **E**

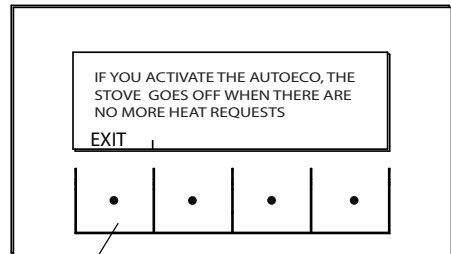

B

The Auto eco mode turns the stove off when the heating system does not require heat depending on the menu-settings-input aux configuration.

AUTO ECO ACTIVE

The AutoEco active parameter (factory settings) is shown on the top right on the control panel display in the main screen. If heat is not required, the stove turns off after the set time, switching to Auto Eco (State 84 - it is possible to see Auto eco in the Information Menu, stove state).

NOTE: With the stove off, if set T is less than T room, or other heat request settings are satisfied the stove does not turn on.

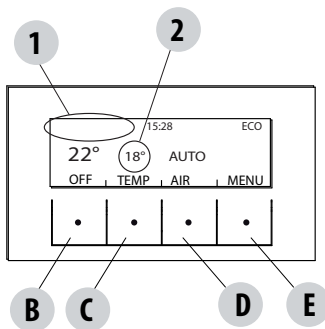

B **C** **D** **E**

1 = no heat request ($T_{\text{room}} > T_{\text{set}}$)

2 = T set

if set temperature is increased $> T_{\text{room}}$ (therefore in this case $> 22^{\circ}\text{C}$) the stove with start-up after a few seconds due to the heat request.

AUTO ECO DEACTIVATED

With the stove on, if Auto eco is deactivated and there are no heat requests (different based on menu-settings-aux input settings) the stove operates at minimum power.

The required condition for restarting is for there to be a heat request for at least 10" consecutively; it is possible to restart if:

- at least 5' have elapsed from when shutdown began
- the TH_2O in the stove is $< T_{\text{set}} \text{H}_2\text{O}$

To modify the function:

from the settings menu - using the arrow keys, select the AUTOECO function, press ok (E key) and press D or C key (arrow key) and select: Activate = to modify the set time from 0 to 30 minutes (factory default 5 minutes)

Deactivate = to deactivate Auto Eco

12-SETTINGS MENU

HYDRO AIR

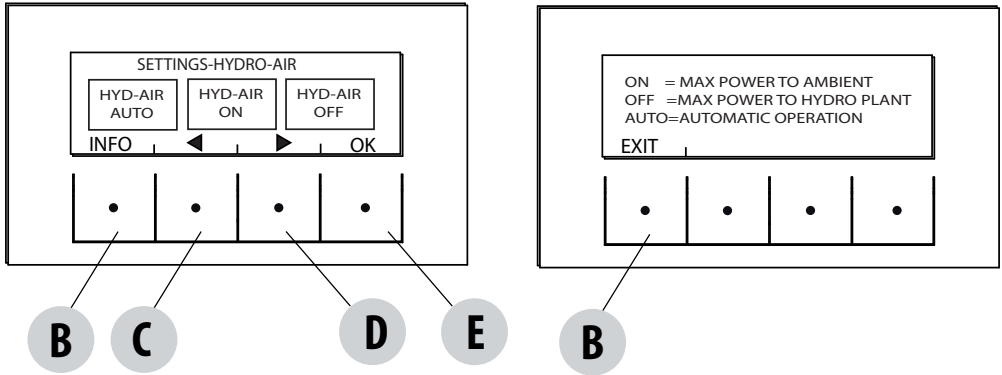

The Hydro Air function can be activated/deactivated manually or managed automatically (factory default setting).

In **Hydro-Air On** mode the internal three-way valve is switched so that the water, before going towards the system, passes through the front radiator, transferring heat to the environment through the fan up to 6 kW (at maximum power with water temperature at 70°C).

In **Hydro-Air Off** mode the internal three-way valve is switched so that stove water goes directly to the system, without passing through the front radiator. In this case power released to the environment may reach 3 kW.

In **Hydro-Air Automatic** mode the three-way valve is managed in an intelligent way by the electronic control in order to release maximum power to the room only when there is an actual heat request from the stove probe. If there is no request from the room, the valve is switched as in OFF mode.

To enter the function:

from the settings menu - press ok (E key), press the D key (arrow key) and scroll up to Hydro-air, press OK (E key) and activate the HYD-AIR AUTO / HYD-AIR ON / HYD-AIR OFF function and press ok "E" key to confirm.

AUGER LOADING (only with the stove off)

This function is for filling the pellet loading system. Can only be activated with the stove off.

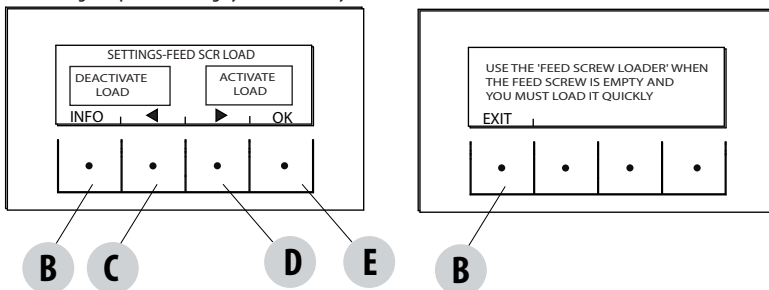

To enter the function:

from the settings menu - press ok (E key), press the D key (arrow key) and scroll up to load auger, press OK (E key) and activate/deactivate the function, press ok ("E" key) to confirm.

12-SETTINGS MENU

PELLET RECIPE

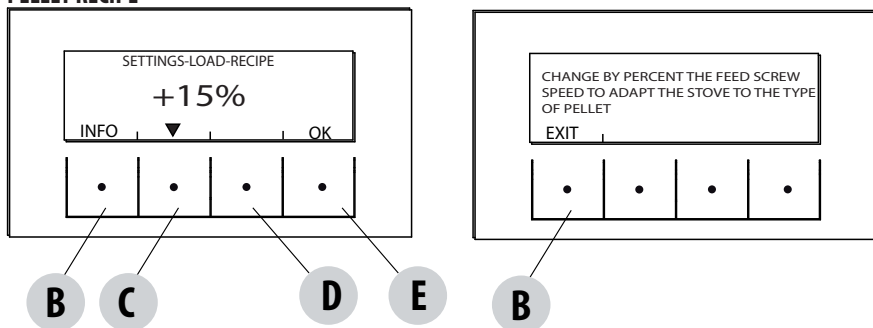

This function is for adapting the stove to the type of pellet in use. As there are many types of pellet available on the market, stove operation can vary considerably according to the quality of the fuel. When the pellets clog up the brazier due to excess loading of fuel, vice-versa if the flame has a tendency to shut-off, it is possible to decrease/increase the amount of pellets in the brazier:

The available values compared to factory settings are:

+15% +10% +5%; 0%; -10% -20% -30%

To modify the pellet recipe, in sequence, press:

from the Settings menu- press ok (E key), press the D KEY (arrow) scroll up to pellet recipe and press OK (E key) and enter the function, using the "C" and "D" keys to modify the parameter and press Ok ("E" key).

ACTIVE +

The pellet type is not a problem because the stoves are equipped with the Active system and automatically adapt to pellet of any length with a diameter of 6-8 mm. Effective and efficient combustion is independent from any type of connection to the flue which, with traditional systems, may constitute a problem during the installation phase.

Thanks to an internal sensor, the stove is extremely reliable and precise. Combustion air is constantly adjusted based on the quantity of pellets present in the brazier, guaranteeing an effective and efficient combustion this way that translates into decreased consumption, emissions and less frequent cleaning.

Thanks to Active plus, it is possible to control and communicate with the stove, even by way of Smartphone and tablet. Since it is possible to manage more evolved gear motors (with continuous operation), and the new pellet stoves equipped with active plus are more silent.

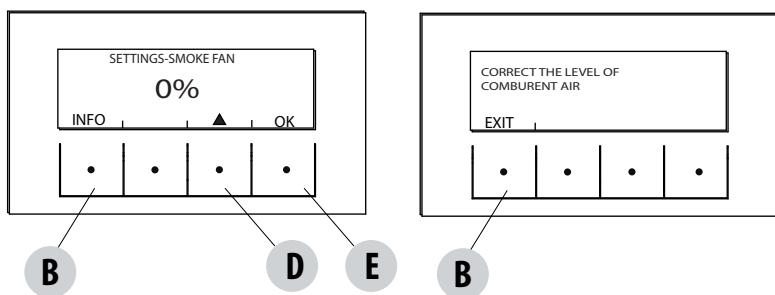

This function is used to adjust combustion air if the flame is too high or too low.

It can be activated from the SETTINGS menu, scroll using the "D" arrow key up to the "Ricetta Aria" (Air recipe) function, press OK using the "E" key, and, using the "D" arrow key modify the parameter and press "ok" "E" key.

The fixed parameters that can be set are: +10; +5; -5; -10

12-SETTINGS MENU

CLEANING

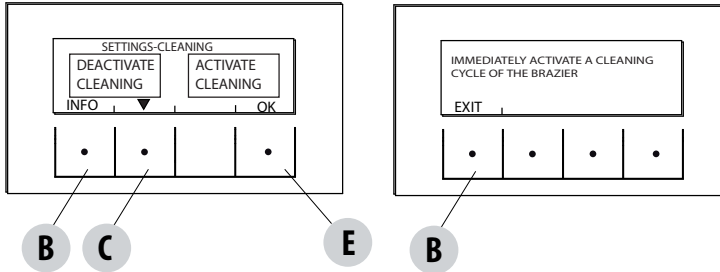

This function can only be activated while the power supply is in the following mode:

from the Settings menu- press ok (E key), press the D key (arrow), scroll up to the “ciclo pulizia” (cleaning cycle) press OK (E key)- Activates/ deactivates cleaning.

This procedure activates the fume extraction fan at the maximum level in order to clean the brazier and expel soot.

LANGUAGE

This function is used to choose the desired language among those set in the control panel.

To enter the function, from the Settings menu - press ok (E key), press the D key (arrow key) and scroll up to language item, press OK (E key) and choose the language among the various ones set and finally press Ok (“E” key) to confirm.

The available languages are: Italian/English/French/German/Spanish/Dutch/Danish

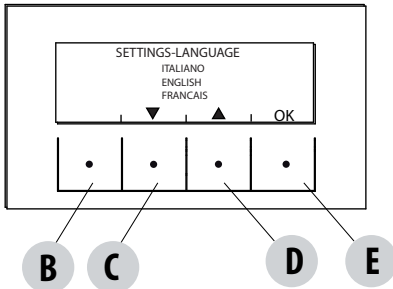

DATE-TIME

This function is used to set date and time.

To enter the function, from the Settings menu - press ok (E key), press the D key (arrow key) and scroll up to the date-time item, press OK (E key) to enter the function. Next, press the “E” (ok) key again to modify day/month/year/hour and minutes. To modify the parameters, use the “C” and “D” (arrow) keys and press the “E” key to confirm.

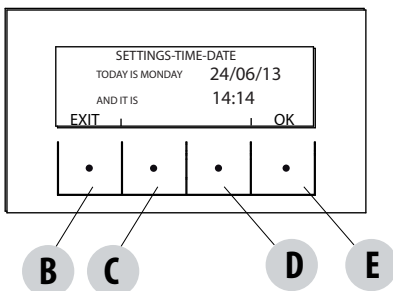

12-SETTINGS MENU

AUX INPUT (using one of the following parameters excludes the other)

The auxiliary input allows choosing the system configuration type based on which the stove is connected.

To enter the function press:

from the Settings menu- press ok (E key), press the D (arrow) key and scroll up to the Aux Input item and press OK (E key). Using the "C" and "D" keys select the desired heating system type and press ok with the "E" key.

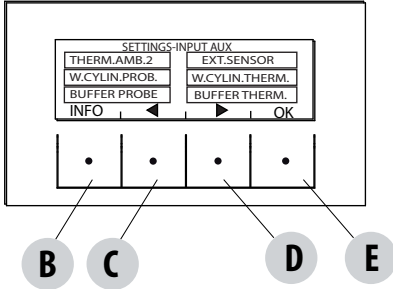

It is possible to connect the following to the auxiliary input:

Room thermostat 2

External probe

Boiler probe

Boiler thermostat

Puffer probe

Puffer Thermostat

Note: The boiler probe/thermostat choice implies the three-way aux output designation.

The puffer probe/thermostat choice implies the pump aux output designation.

- **Room Therm.2**

The stove heat request may take place from any part of the room probe or from the "Termostato Amb 2" (Room thermostat 2) installed in a room that is different from the one where the stove is positioned and is connected to terminals 1 and 2 of the back terminal board. Contact closing the terminal kicks off the heat request.

Notes: Installation of this thermostat is optional, the stove can also operate without it. Since the contact is N.O., the room probe is the only heat request command.

Possible active weekly programming does not act on Room Thermostat 2 but rather on the probe on board the stove.

12-SETTINGS MENU

• External probe

It makes it possible to work with system temperature adjustment. If installing an external probe on terminals 1 and 2 (NTC 10KOhm at 25°C b=3435) water temperature is automatically calculated by the electronics based on the external temperature according to the curves shown below.

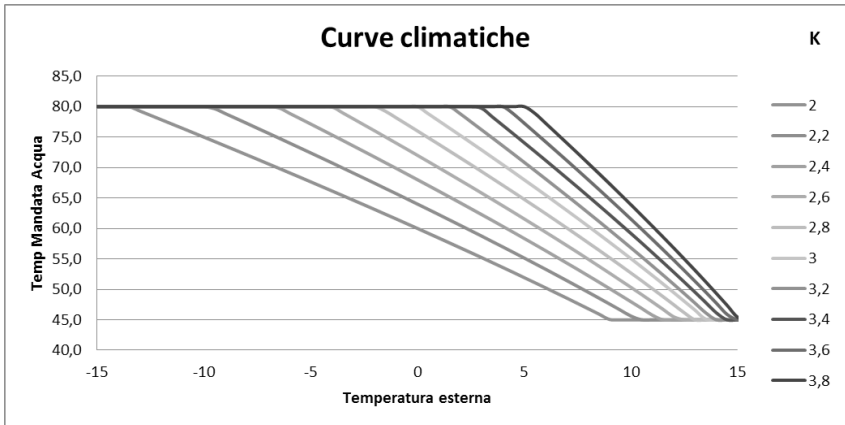

The external probe must be installed on an external wall exposed towards North or North-West. If necessary, it is possible to correct the value read by the probe of + 5 -5°C.

• Boiler probe

To activate this option, connect a probe (NTC 10KOhm at 25°C b=3435) to points 1 and 2 of the back 9 pole terminal board.

The heat request occurs when the boiler probe reads a temperature that is 2°C below the one set by the accumulation temperature marked by a tap in the temperature menu.

In this configuration the aux output is configured as a potential free contact to control the 3-way valve (contact 7-8-9 of the back 9 pole terminal board)

• Boiler thermostat

To activate this option, connect a Normally Open (N.O.) contact thermostat to points 1 and 2 of the back 9 pole terminal board.

The heat request occurs when boiler thermostat closes the contact.

Even with this configuration the Aux output is configured as a potential free contact to control the 3-way valve (contact 7-8-9 of the back 9 pole terminal board).

• Puffer probe

To activate this option, connect a probe (NTC 10KOhm at 25°C b=3435) to points 1 and 2 of the back 9 pole terminal board.

The heat request occurs when the boiler probe reads a temperature that is 2°C below the one set by the accumulation temperature marked by a radiator in the temperature menu.

During the installation with puffer, stove operation is only and exclusively determined by the puffer probe and not by the room probe. The purpose of the room probe on the stove is only to control the heating system pump controlled by the potential free contact N.O.: (max 5 ampere, not suitable for brushless pumps with upper start-up current) on terminals 8-9.

Example of operation with Hydro Air On or Auto:

- if the puffer is satisfied but the room probe is not, with eco stop active the stove shuts off (continuing to disburse heat through the room fan up until shut-off)
- if the puffer is satisfied but the room probe is not, with eco stop deactivated, the stove remains on at minimum power. In this case hot water from the puffer is used through the pump to heat the front radiator
- if the puffer calls for heat and the room probe does not, the fan behaves based on "Hydro Air" and "Ventilatore" (Fan) settings.

12-SETTINGS MENU

- Puffer thermostat**

To activate this option, connect a Normally Open (N.O.) contact thermostat to points 1 and 2 of the back 9 pole terminal board. Even with this configuration the purpose of the room probe on the stove is only to control the heating system pump controlled by the potential free contact on terminals 7-8-9.

POS.1-2 AUX INPUT: EXTERNAL THERMOSTAT/THERMOSTAT BOILER/PUFFER/BOILER PROBE/PUFFER	POS.5-6 HOME AUTOMATION
POS.3-4 ROOM INPUT : ROOM PROBE	POS.7-8-9 AUX OUTPUT RELAY

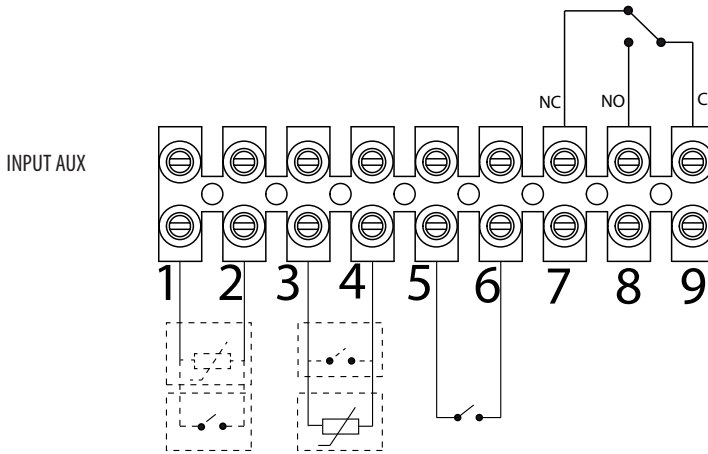

12-SETTINGS MENU

HYDRO AIR STOVE PRINCIPLE DIAGRAMS



The following diagrams are to be used only as a guideline. For proper connection, always follow the notes for the plumbing and heating installer. The plumbing system must meet local, regional or national requirements. Installation and verification of operation is to be performed only by specialized, authorized personnel. The manufacturer will not be held liable for noncompliance with the provisions listed above.

HEATING ONLY CONFIGURATION

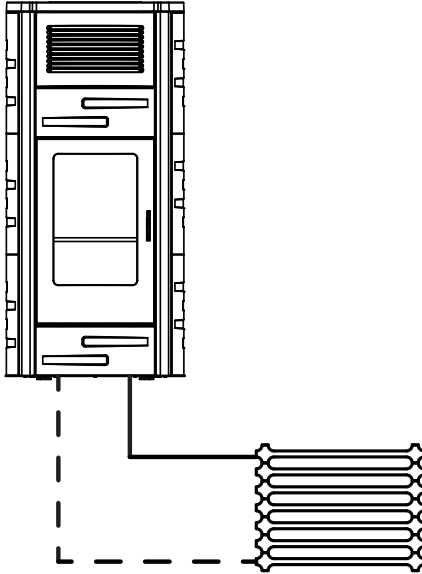

BOILER CONFIGURATION

POS.1-2 = BOILER
PROBE/THERMOSTAT

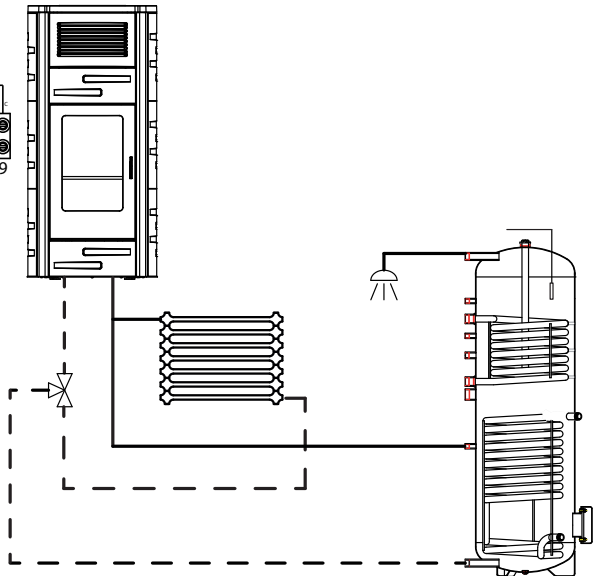
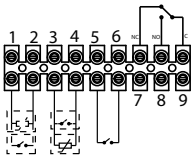

12-SETTINGS MENU

HYDRO STOVE WITH PUFFER CONFIGURATION

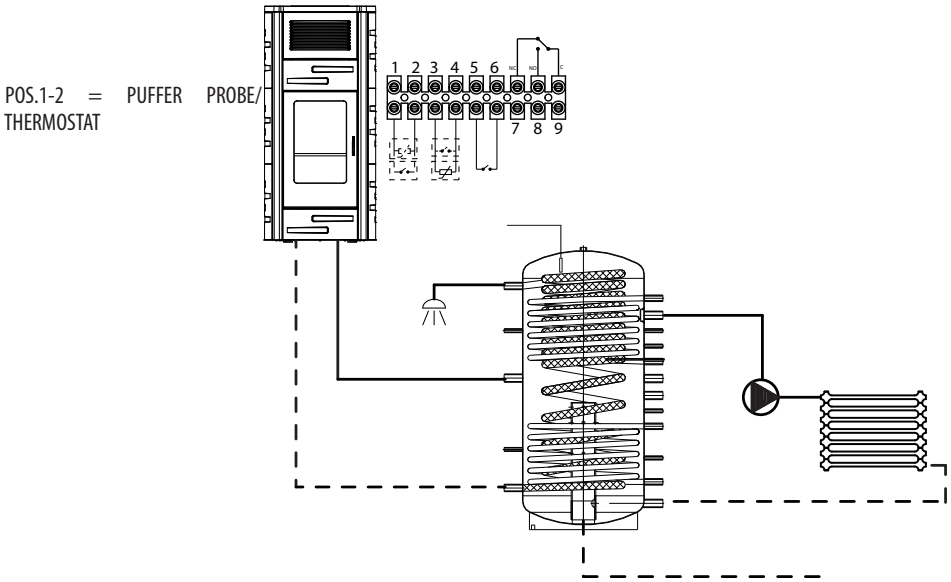

ONLY FOR UK

MCZ Hydro Stoves (Active System) DUO HYDRO

Wiring for S-Plan Systems

These notes must be read in conjunction with the full installation instructions

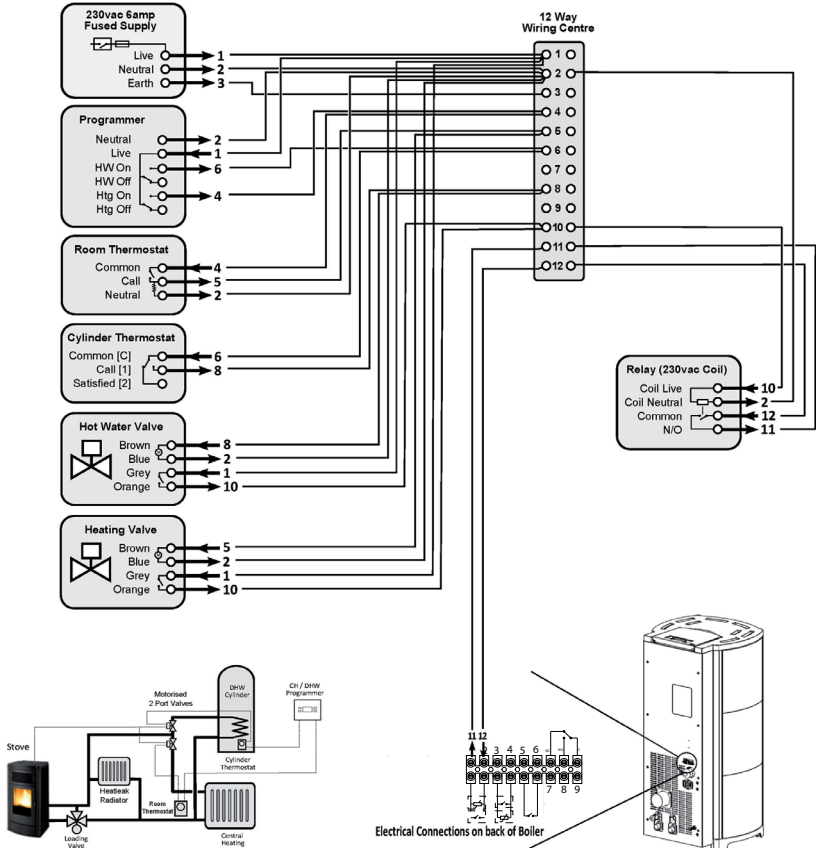

Simplified Schematic of S-Plan System

WARNING: The external thermostat terminals on MCZ stoves and boilers are volt-free. **On no account must a mains voltage signal be connected.**

ONLY FOR UK

MCZ Hydro Stoves (Active System) DUO HYDRO Wiring for Y-Plan Systems

These notes must be read in conjunction with the full installation instructions

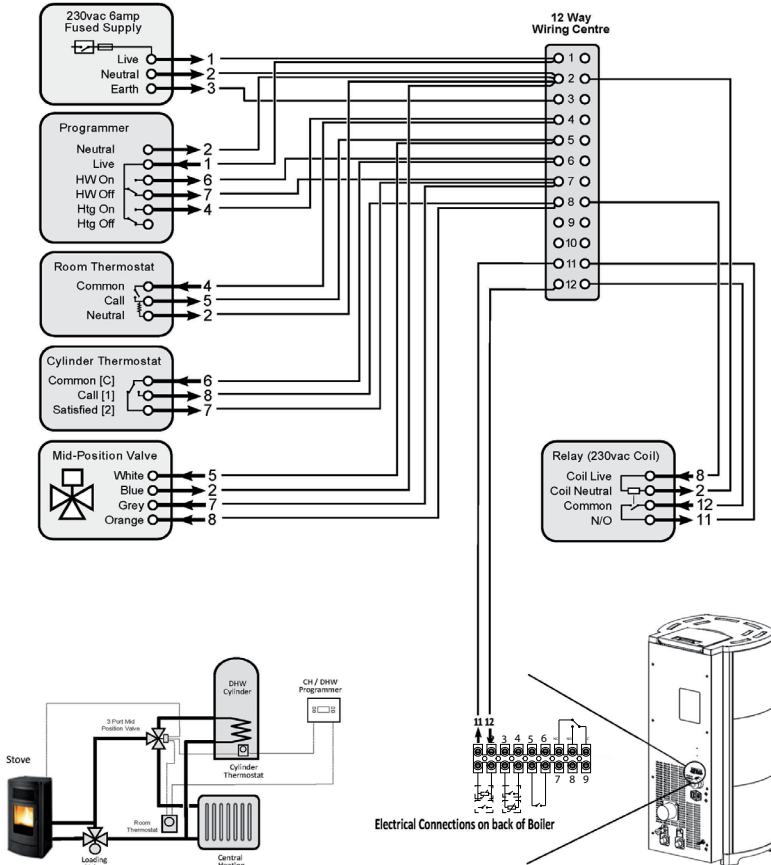

Simplified Schematic of Y-Plan System

WARNING: The external thermostat terminals on MCZ stoves and boilers are volt-free. **On no account must a mains voltage signal be connected.**

ONLY FOR UK

MCZ Hydro Stoves (Active System)

DUO HYDRO

Wiring for Thermal Store or Buffer Systems where time control is by use of external programmer.

These notes must be read in conjunction with the full installation instructions

Note: Separate controls are required for operation of the Central Heating and DHW zones (not shown), and those controls are not interlocked with the stove and cylinder thermostat.

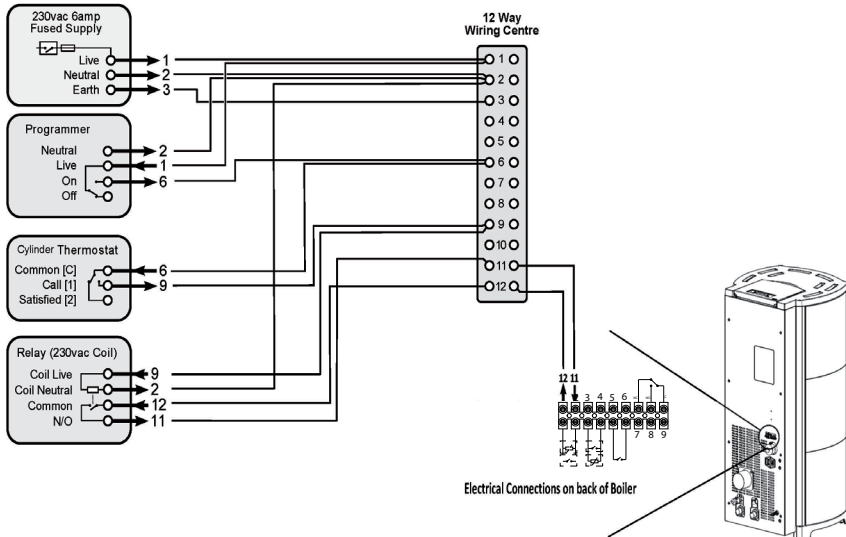

WARNING: The external thermostat terminals on MCZ stoves and boilers are volt-free. On no account must a mains voltage signal be connected.

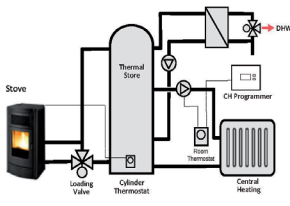

Simplified Schematic of Thermal Store System

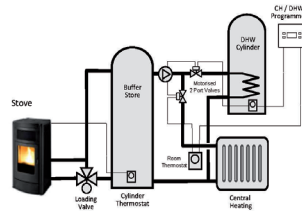

Simplified Schematic of Buffer Store System

ONLY FOR UK

MCZ Hydro Stoves (Active System)

DUO HYDRO

Wiring for Thermal Store or Buffer Systems where time control is by use of onboard programmer in stove.

These notes must be read in conjunction with the full installation instructions

Note: Separate controls are required for operation of the Central Heating and DHW zones (not shown), and those controls are not interlocked with the stove and cylinder thermostat.

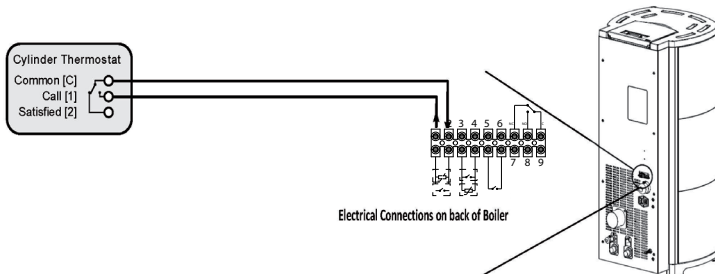
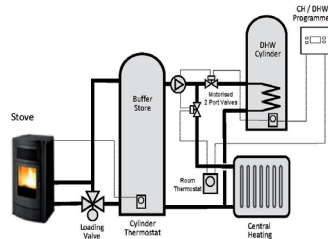
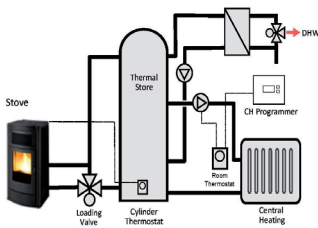

WARNING: The external thermostat terminals on MCZ stoves and boilers are volt-free. **On no account must a mains voltage signal be connected.**

12-SETTINGS MENU

OUTPUT AUX

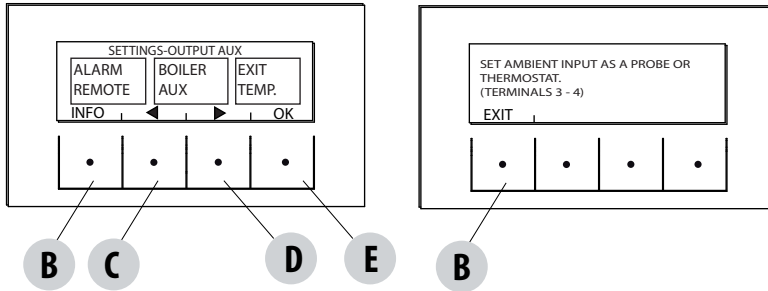

The AUX output makes it possible to use a relay contact, based on the system configuration type chosen in the Aux Input menu. It acts on contact 7-8-9 of the external terminal board. The functions can only be selected if boiler or puffer configuration has not been chosen in the Aux Input menu and are:

- Remote alarm (9-8=C-NO)
- Auxiliary boiler (9-7=C-NC)
- Auxiliary output in temperature (9-8-7=C-NO-NC)

To enter the function press:

from the Settings menu- press ok (E key), press the D (arrow) key and scroll up to the Aux Output item and press OK (E key). Using the "C" and "D" keys to select the Remote Alarm(Aux boiler/Output in temp and press OK ("E" key).

- If the Aux output is set on Remote Alarm, the NO contact is closed when an alarm is present.
- If the Aux output is set to Auxiliary Boiler, the NC contact remains closed in all alarm states, in = "OFF" state, in 80 "Shutdown" state and in 51 "COOL" state. Under all conditions it remains open.
- Output at temperature: the NO contact closes when Boiler temperature exceeds the value set by the user. It can be set from 30 to 60, it is used, for example, to disconnect the aux boiler above a certain temperature (using the NC contact) or to start an external pump at temperature (using the NO contact)
- If the boiler configuration has been chosen, the Aux contact is fixed at "Valvola tre vie bollitore" (Three-way boiler valve): the contact switches when a heat request is received from the boiler.
- If the Puffer configuration has been chosen, the Aux contact is fixed at "Comando pompa" (Pump Control): the NO contact closes when a heat request is received from the Room PROBE

12-SETTINGS MENU

ROOM INPUT

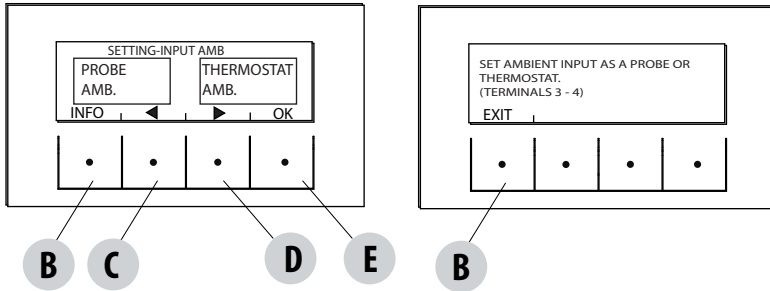

The room input is used to set the probe or the thermostat at terminals 3-4 of the back terminal board of the stove. The stove has the room probe set as default factory settings.

Selecting the thermostat it is possible to replace the probe on the stove with a thermostat that requests heat when the contact is closed. To enter the function press: from the settings menu - press ok (E key), press the D key (arrow) and scroll up to Room Input, press OK (E key) and select room thermostat, press E key to confirm.

Attention!!! If room temperature is selected, weekly hourly programming is not available.

PUMP ON T

This function enables adjustment of the pump activation temperature.

To enter the function press:

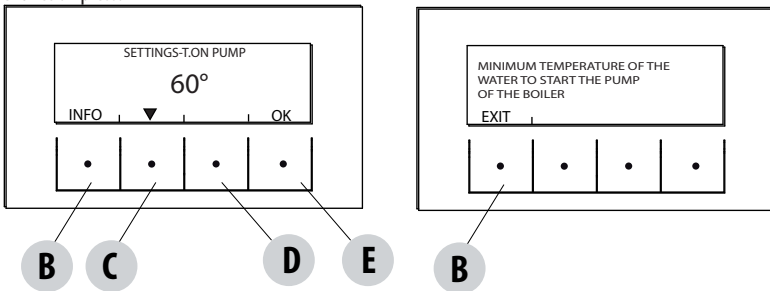

from the Settings menu- press ok (E key), press the C-D key (arrow) and scroll up to temp.On pump, press OK (E key)- Modify the temperature using the central C and D keys, press the E key to confirm.

12-SETTINGS MENU

PWM PUMP

This function is used to set high efficiency pump speed.

To enter the function press:

from the Settings menu- press ok (E key), press the C-D key (arrow) and scroll up to PWM Pump, press OK (E key)- Modify the percentage using the central C and D keys, press the E key to confirm.

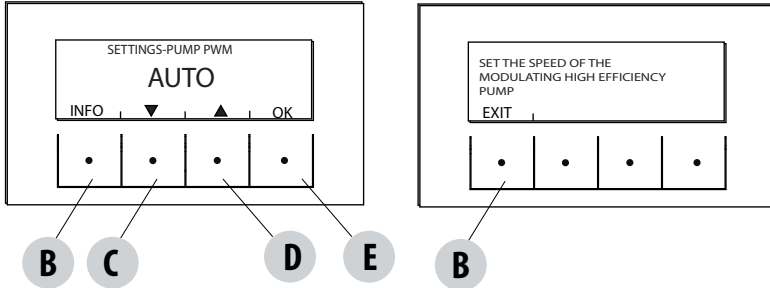

FUNCT. ANTI-FREEZE

It consists of activating the pump (level 1) or the stove (level 2) and is automatically activated by the temperature read by the stove probe and the temperature read by the external probe (if present and connected to the aux input).

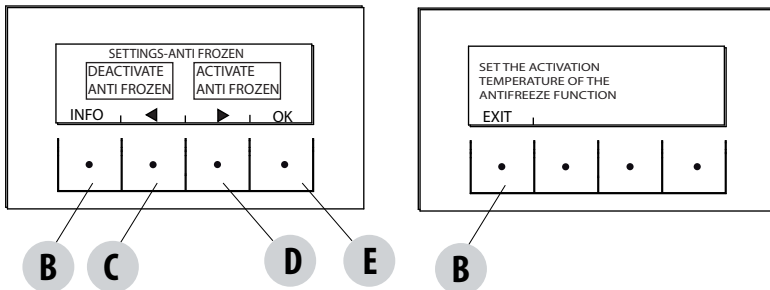

The level 1 anti-freeze activation conditions (PUMP ON) are:

boiler temp < anti-freeze set +3°C

The level 2 anti-freeze activation conditions (PUMP and FLAME ON) are:

boiler temp = anti-freeze set

Anti-freeze activation conditions on external probe (if present) are:

ext_filtered temp < anti-freeze set -3

To enter the function, press and adjust anti-freeze set:

from the Settings menu- press ok (E key), press the C-D key (arrow) and scroll up to Antifreeze function and press OK (E key)- Activate and set (from 1 to 5°C) or deactivate the function and press the E key to confirm.

PELLET SENSOR

Optional Function.

12-SETTINGS MENU

MODBUS COM.

Is a communication system that makes it possible for the stove to receive commands from a Smartphone/tablet through a Web/Wi-fi interface.

To enter the function press:

from the settings menu - press ok (E key), press the C-D key (arrow) and scroll up to Modbus com. and press OK (E key)- Set the address and press E key to confirm.

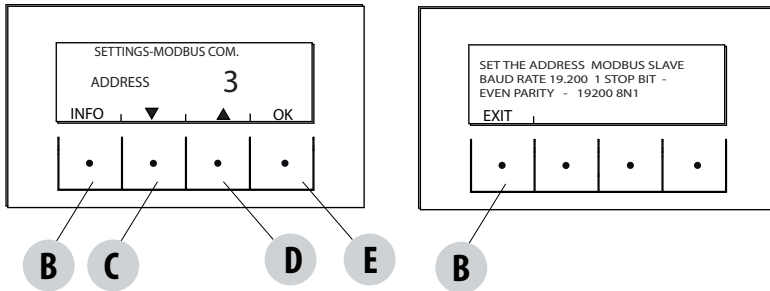

DISPLAY

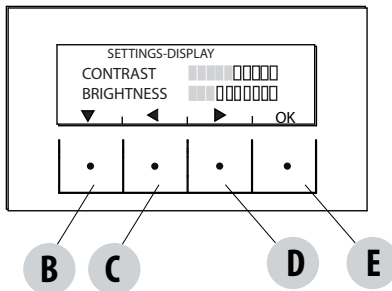

Adjust display contrast and brightness. This function is found in:

from the Settings menu- press ok (E key), press the C-D key (arrow) and scroll up to Display, press OK (E key)- Modify the settings using the B - C - D keys and press the E key to confirm.

13-TECHNICAL MENU

TECHNICAL MENU

To access the technical menu you must contact the assistance centre as it requires a password.

To make changes in the technical menu, enter the SETTINGS menu, press the "E" (OK) key, scroll using the "C"- "D" arrows and select Technical menu and press OK (E key)- Enter the password and press the E key to confirm.

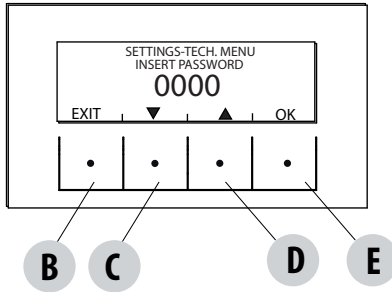

To enter the password:

using the C and D keys, set the numbers (1-2-3....9) with the E (OK) key and move on to the next digit, once the four digits have been entered, press the E key to enter the technical menu.

The technical menu displays the following parameters:

- ACTIVE +
- FUMES ANALYSIS F.
- CALIB.ACTIVE
- CALIB.S.FUMES
- DIAGNOSTIC
- PARAMETERS
- BOLL ADVANCE
- RESET HOURS

14-SAFETY DEVICES AND ALARMS

SAFETY DEVICES

The product is fitted with the following safety devices

ACTIVE +

Besides adjusting the stove operation, it also guarantees that the pellet loading auger is blocked if unloading or there is significant back pressure.

SMOKE TEMPERATURE PROBE

Detects the temperature of the smoke, thereby enabling start-up or stopping the product when the temperature drops below the preset value.

CONTACT THERMOSTAT IN THE FUEL HOPPER

If the temperature exceeds the preset safety level, it immediately shuts down the running of the stove.

WATER THERMOSTAT

If the temperature exceeds the preset safety level, it immediately shuts down the running of the stove.

WATER TEMPERATURE SENSOR

When the water reaches the stop temperature (85°C) the probe automatically instructs the boiler to carry out automatic "OFF Stand-by" shut-off.

ELECTRICAL SAFETY

The stove is protected against violent changes in current by a general fuse located in the control panel at the back of the stove. Other fuses that protect the circuit boards are located on the latter.

SMOKE FAN

If the fan stops, the electronic board shuts off the supply of pellets in good time, and an alarm message is displayed.

GEAR MOTOR

If the reduction motor stops, the stove will continue to run until the flame goes out due to lack of fuel and until a minimum level of cooling is reached.

TEMPORARY POWER CUT

When a power cut is less than 10" the stove returns to its previous operating state; if it is more, it executes a cooling/re-ignition cycle.

FAILED START-UP

If during ignition no flame develops, the stove will go into alarm condition.

ANTI-FREEZE FUNCTION

If the probe in the boiler detects a water temperature of less than 5°C, the circulation pump is automatically activated to keep the system from freezing.

PUMP ANTI-SEIZURE FUNCTION

If the pump is not used for prolonged periods, it is activated periodically for a few seconds to keep it from seizing up.

14-SAFETY DEVICES AND ALARMS



TAMPERING WITH THE SAFETY DEVICES IS PROHIBITED

If the stove is NOT used as described in this instruction booklet, the manufacturer refuses to accept any responsibility for damage to persons and property that may arise. The manufacturer furthermore refuses to accept responsibility for damage to persons and property arising from the failure to observe all the rules contained in the manual and in particular:

- **All the necessary measures and/or precautions must be adopted when performing maintenance, cleaning and repairs.**
- **Do not tamper with the safety devices.**
- **Do not remove the safety devices.**
- **Connect the stove to an efficient smoke extraction system.**
- **First, check that the environment where it is to be installed is properly ventilated.**



Only after eliminating the cause of the intervention of the safety system is it possible to re-ignite the stove and thus restore its automatic operation. This manual will help you understand which anomaly has occurred, and explain how to intervene according to the alarm message displayed on the stove.

14-SAFETY DEVICES AND ALARMS

ALARM ALERTS

If there is an operational anomaly, the stove enters the alarm phase displaying the problem that has taken place through a code, a brief description of the alarm type and an acoustic warning.

The following table describes the possible alarms indicated by the stove, associated to the respective code that appears on the panel and helpful tips to solve the problem.

B = RESET (cancels alarm)

C = INFO (provides information on the alarm type)

E = MENU

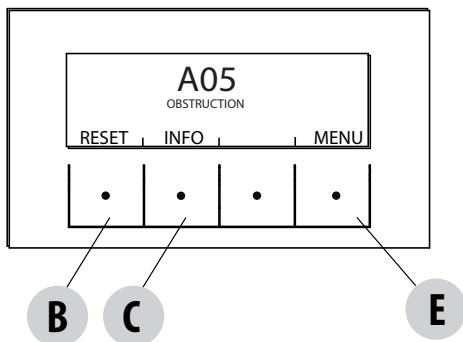

WRITTEN ON THE DISPLAY	TYPE OF PROBLEM	SOLUTION
A01 NO IGNITION	The fire does not ignite. (without acoustic alarm)	Check the level of pellets in the tank. Check that the brazier rests correctly in its seat and has no visible deposits or unburnt pellets. Check whether the ignition plug becomes hot. Empty and clean the brazier before relighting.
A02 NO FLAME	The fire goes out abnormally. (without acoustic alarm)	Check the level of pellets in the tank. Check that the brazier rests correctly in its seat and has no visible deposits of unburned pellets.
A03 PLT SAFETY	Pellet tank temperature is too high	Wait for the cooling phase to end, cancel the alarm and reduce pellet loading (SETTINGS MENU - Pellet recipe). If the alarm persists, contact the service centre.
A04 FUME TEMP	Fume temperature is too high	Wait for the cooling phase to end, cancel the alarm and reduce pellet loading (SETTINGS MENU - Pellet recipe). If the alarm persists, contact the service centre.
A05 OBSTRUCTION	Chimney flue clogged	Verify brazier clogging, smoke duct, lower compartment and door closing. If the alarm persists, contact the service centre.

14-SAFETY DEVICES AND ALARMS

WRITTEN ON THE DISPLAY	TYPE OF PROBLEM	SOLUTION
A08 FLUE GAS FAN	Faulty smoke fan.	Check that the lower compartment is clean (see dedicated stove cleaning pages) and verify that it is not obstructed, is clean and cancel the alarm. If the alarm persists, contact the service centre.
A09 SMOKE TEMPERATURE PROBE	Smoke sensor fault.	Contact an authorised service centre to have the component replaced and, if needed, replace the component.
A11 GEAR REDUCER	Auger gear reducer fault.	The component is not working regularly. Contact an authorised service centre to have the component replaced and, if needed, replace the component.
A13 BOARD TEMP	Electronic board overheating	Wait for the cooling phase to end, cancel the alarm and reduce pellet loading (SETTINGS MENU - Pellet recipe). If the alarm persists, contact the service centre. .
A14 ACTIVE SENSOR	Active sensor anomaly	Active Plus sensor operation anomaly. Contact an authorised service centre to have the component replaced and, if needed, replace the component.
A18 WATER SIC	Water thermostat intervention	Water temperature is too high or thermostat operational anomaly. If the alarm persists, contact the service centre.
A19 WATER PROBE	Fault with water sensor	Possible fault in the safety component. Contact an authorised service centre to have the component replaced and, if needed, replace the component.
A20 AUX PROBE	Auxiliary probe fault	Possible component fault. Check that the probe inserted in the system respects the characteristics specified in the instructions (see external probe). Contact an authorised service centre to have the component replaced and, if needed, replace the component.

Exiting the alarm conditions



NEVER open the appliance door whilst the stove is either in the initial startup or on its shut down cycle, pellets will still be smoldering or therefore volatiles may be present.

ATTENTION!

If during operation or initial ignition you encounter smoke spillage in to the room from the appliance or the flue then please switch off the appliance, ventilate the room and contact the installation / service engineer immediately.

14-SAFETY DEVICES AND ALARMS

When the stove enters an alarm state, an automatic cooling/shut-off phase begins, at the end of which the cause of the alarm is displayed on the small panel.

Before resetting the alarm, follow the controls indicated in the previous table, and then press the RESET key for a few seconds (or remove power to the stove using the main ON/OFF switch on the back of the stove).

If the indicated actions do not resolve the problem, the alarm condition will occur once again with different timing based on the alarm type: in this case, contact technical assistance.

SHUT DOWN

If the shut down key is pressed or one of the following conditions occurs:

- power request ends (Power = 0) for Ecstop, Timer, Sleep
- an alarm condition occurs
- water overheating occurs

the stove enters the shut down and thermal cooling phase that includes automatically executing the following phases:

- pellet loading stops
- the room fan maintains the set speed until it cools down
- the fumes extractor is activated at maximum speed and remains on for a fixed period of 5 minutes, at the end of which the stove off temperature is reached.

During the shut down phase the small panel displays the wording OFF (see screen) but if it is in shut down due to an alarm condition, the small panel displays the related code (See alarms table)

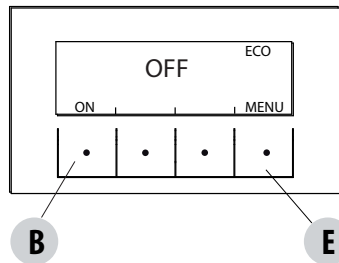

BLACKOUT WITH STOVE ON

If power is lost for less than 10" from stove start-up, it is repositioned in the phase where it was before the power failure.

If the loss of power exceeds 10", when the stove is powered once again, it goes back to the previous operational condition with the following procedure it

- carries out a cooling phase, during which the panel displays OFF BLACKOUT
- restarts the stove

If the stove is in ignition phase when the blackout occurs, it will not turn back on once the power is restored (there is a risk that residual pellets are present in the brazier) and the panel will display OFF BLACK-OUT.

If the ON key is pressed during the cooling phase, the stove stops executing the blackout restore state and it proceeds with ignition as requested by the command. In the same way, pressing OFF is interpreted as a shut off command.

15-RECOMMENDATIONS FOR A SAFE USE

RECOMMENDATIONS FOR A SAFE USE



ONLY A SUITABLE INSTALLATION ACCORDING TO THE UK BUILDING REGULATIONS (ADJ) AND A PROPER MAINTAINANCE AND CLEANING OF THE PRODUCT CAN ASSURE YOU THE CORRECT FUNCTIONALITY AND A SAFE USE OF YOUR STOVE (ONLY FOR UK).

We wish to notify you that we have been made aware of incidents involving domestic heating pellet stoves resulting from the stoves having been incorrectly installed or inadequately maintained. In some cases the incident provoked an explosion that caused the glass door on the stoves to shatter.

We would like to assure you that all of our products are very safe and are certified to the required European standards. The ignition system has been tested carefully to increase the lighting efficiency and avoid any trouble even in the worst working condition. Moreover our structures are also provided with a safety device studied to discharge the eventual overpressure in combustion chamber, and avoid any damage to the product and consequent risk for the final user. However, like any stove, our stoves need to be properly installed and maintained if they are to work safely.

Our studies suggest that these explosions are mainly caused by a combination of some or all of the following factors:

- Clogged brazier holes or a deformed brazier, resulting from insufficient maintenance, creating the conditions for a delayed ignition causing a build up of unburnt gases
- Insufficient combustion air due to the stove not having a big enough air inlet or not having an air inlet at all
- The use of smoke connections or flue pipe assembly which don't comply with UK regulations and which don't create the draught required to effectively suck the smoke outside (e.g. too many bends in the flue).
- Partially blocked flue pipes, which indicates poor maintenance, reducing the draw on the chimney making ignition difficult.
- The chimney terminal not complying with our installation instructions and failing to prevent potentially dangerous down-draught. This component becomes essential when the stove is installed in windy areas like coastal zones.

Any of the above factors or any combination of them could generate unburnt gasses which in the worst cases could explosively ignite when there becomes enough oxygen present.

To avoid this rare but not impossible inconvenient, first of all the installation shall be done in compliance with UK building regulations and the suggestions described in this manual.

Furthermore it's absolutely important to respect the following simple rules:

- The brazier shall be always layed down in its proper position before any use of the product, removing completely the dirt if present in the base plate
- Pellets must not be fed manually into the brazier, both before ignition and during the working condition.
- Eventual accumulated unburnt pellets in the burner after a failed ignitions must be removed before lighting
- If a failed ignition affects the product repeatedly, despite a clean brazier and a usual fuel loading, we recommend that you immediately stop using the stove and contact a qualified technician to check the stove functionality.

The respect of these suggestions is absolutely enough to guarantee a safe ignition and to avoid any inconvenient to the product.

If the above precautions are not fulfilled, and the ignition shows an abnormal amount of pellet in the brazier and a consequent heavy generation of unburned gas in the combustion chamber, respect carefully the following suggestions:

- Do not switch off the electrical power from the stove for any reason: this would arrest the gas exhaust blower with a consequent spread of smoke into the room.
- Precautionally open the windows to ventilate the installation room from eventual smoke outlet in ambient (the flue gas outlet could work not properly).
- Do not open the fire door: this would affect the regular smoke evacuation from the chimney.
- Simply switch off the stove by pressing the on/off button in the control panel (not the rear button of power supply!), and wait till the smoke has been evacuated completely.
- Before any re-lighting attempt, clean completely the brazier and its air passages from any dirt and unburned pellet; put it in the proper position removing the dirt eventually present in the base plate. If a repeated failed ignition happens, stop using the stove and contact a qualified technician to check the stove and chimney functionality

16-CLEANING AND MAINTENANCE

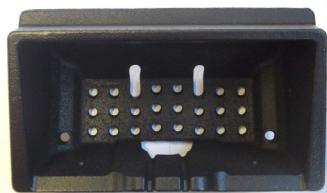

EXAMPLE OF A CLEAN BRAZIER



EXAMPLE OF A DIRTY BRAZIER

Only a proper maintenance and cleaning of the product can assure you the correct functionality and a safe use of your stove.



ATTENTION!

All the cleaning operations of all parts must be performed with the product completely cold and the plug disconnected.

Disconnect the product from the 230V power supply before performing any maintenance operation.

The product requires little maintenance if used with certified high quality pellets.

DAILY OR WEEKLY CLEANING PERFORMED BY THE USER

Brazier cleaning

Before ignition, always clean the “T” brazier and remove any ash or incrustation from it that might obstruct the air flow holes, paying attention to hot ash. In the case of ignition failure, or if fuel in the tank runs out, unburned pellets may accumulate in the brazier. Always empty the residue in the brazier before each start-up. Only if ash is completely cold may a vacuum cleaner be used to remove it. In this case, use a suitable vacuum cleaner to remove small sized particles.



REMEMBER THAT ONLY A CORRECTLY POSITIONED AND CLEAN BRAZIER CAN GUARANTEE THE IGNITION AND OPTIMAL OPERATION OF YOUR PELLET PRODUCT. IN CASE OF FAILED IGNITION AND AFTER ANY OTHER LOCK STATE OF THE PRODUCT, IT IS ESSENTIAL TO EMPTY THE BRAZIER BEFORE PROCEEDING TO RESTART.

For the brazier to be cleaned properly, remove it from its housing completely and thoroughly clean all the holes and the grate on the bottom. If good quality pellets are used, you will normally only need to use a brush to restore the optimal operating conditions of the component.

Ash tray cleaning

Remove and empty the “U” ash tray. Wipe away any residual ash before reinserting the tray. Your experience and the quality of the pellets will determine the ash tray cleaning frequency. However, it is recommended not to exceed 2 or 3 days.

CLEANING THE GLASS

It is recommended to clean the ceramic glass with a dry brush, or if it is very dirty, spray a little specific detergent and clean with a cloth.



ATTENTION!

Do not use abrasive products and do not spray the glass cleaning product on the painted parts and on the door gaskets (ceramic fibre cord).

16-CLEANING AND MAINTENANCE

CLEAN THE EXCHANGER AND THE COMPARTMENT BENEATH THE BRAZIER EVERY 2/3 DAYS

Cleaning the exchanger and the compartment beneath the brazier is a simple operation but very important if the boiler is to maintain optimal performance.

We therefore recommend cleaning the internal exchanger every 2-3 days, performing these simple operations in sequence:

- **Activate the "PULIZIA" (CLEANING) function** – with the stove on press - menu ("E" key), select "IMPOSTAZIONI" (SETTINGS) using the "C" and "D" key and press OK ("E" key), scroll using the "C" and "D" keys and select "CICLO PULIZIA" (CLEANING CYCLE), confirm pressing "OK" ("E" key), activate the "ATTIVA CICLO DI PULIZIA" (ACTIVATE CLEANING CYCLE) function, confirm by pressing OK ("E" key). This procedure starts the smoke extractor on the maximum setting to expel the soot that becomes dislodged when the exchanger is cleaned.
- **Clean the pipe unit** - Using the provided hook "A", shake the rods located beneath the top firmly 5-6 times. This will remove any soot that has deposited on the exchanger's smoke ducts during normal stove operation.
- **Deactivate the "CICLO PULIZIA" (CLEANING CYCLE) function** – this function is deactivated by pressing the "DISATTIVA CICLO PULIZIA" (DEACTIVATE CLEANING CYCLE).
- **Clean the smoke conveyor compartment (fig. in following page)** - The stove is equipped with a removable ash tray "G" which collects any accumulations of soot and ash.
- Once cleaning is finished reposition the top and the ash tray "G".



If such cleaning is not done every 2-3 days the stove could go into alarm caused by ash clogging after several hours of operation.

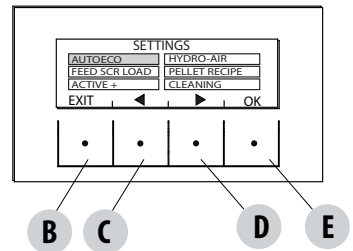
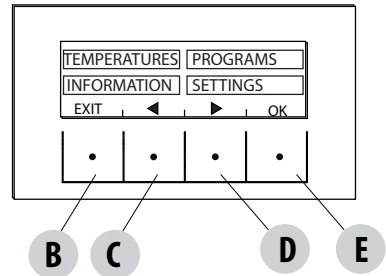
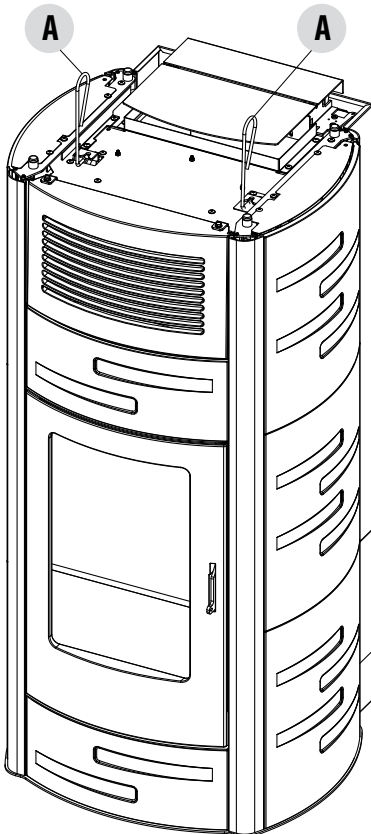

16-CLEANING AND MAINTENANCE

CLEANING THE LOWER COMPARTMENT

Clean around the brazier "C". Remove the tray "D" and the brazier "C". Loosen the screws and remove the fumes plug "E" and using the nozzle of a vacuum cleaner, remove any ash and soot that may have built up in the lower exchanger indicated by the arrow.

Before putting the cap "E" back, changing gasket "F" is recommended

Before removing ash using a vacuum cleaner, it is recommended to clean the internal walls of the stove using the supplied scraper.

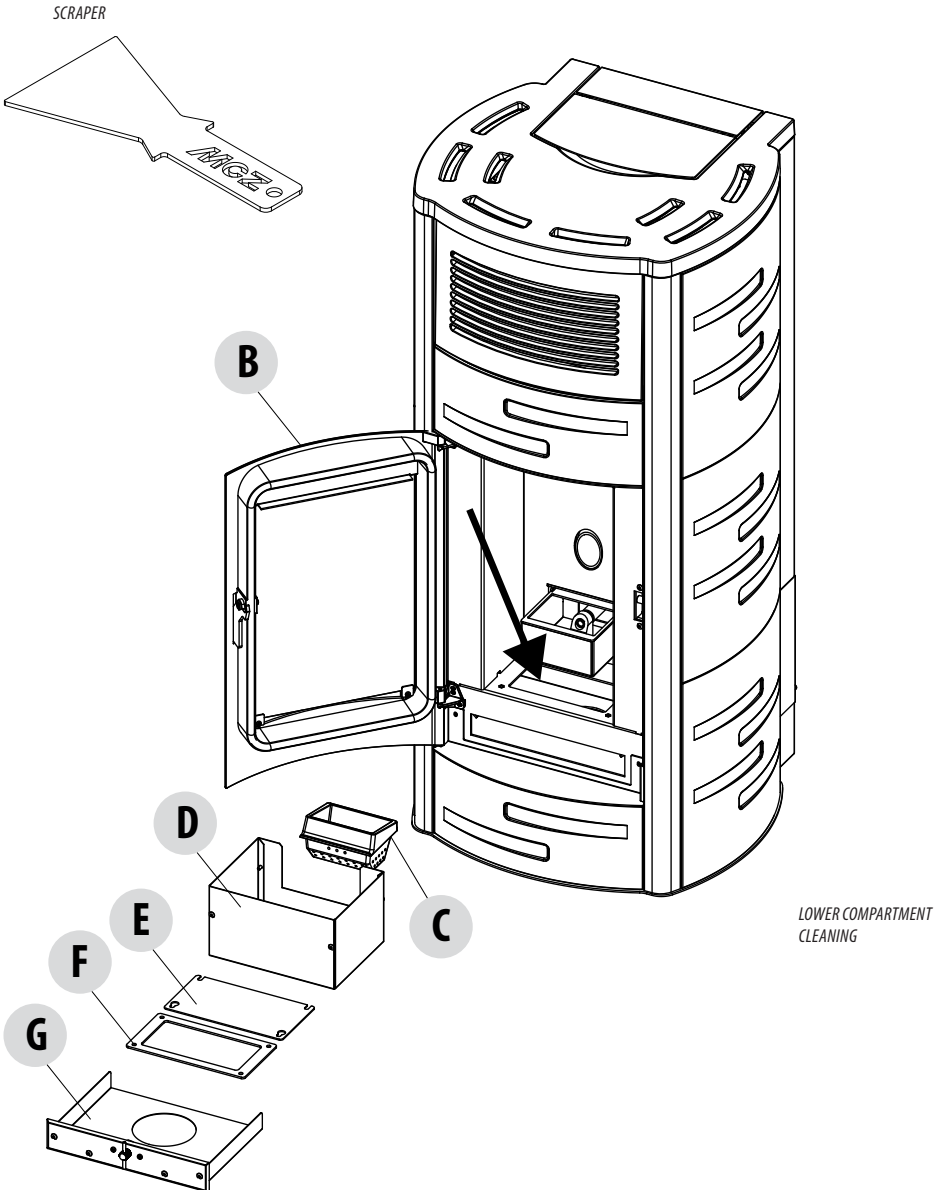

16-CLEANING AND MAINTENANCE

PERIODIC CLEANING PERFORMED BY A QUALIFIED TECHNICIAN CLEANING THE EXCHANGER AND PIPE UNIT

In order to clean the exchanger and the pipe unit, while the stove is cold, proceed in the following manner:

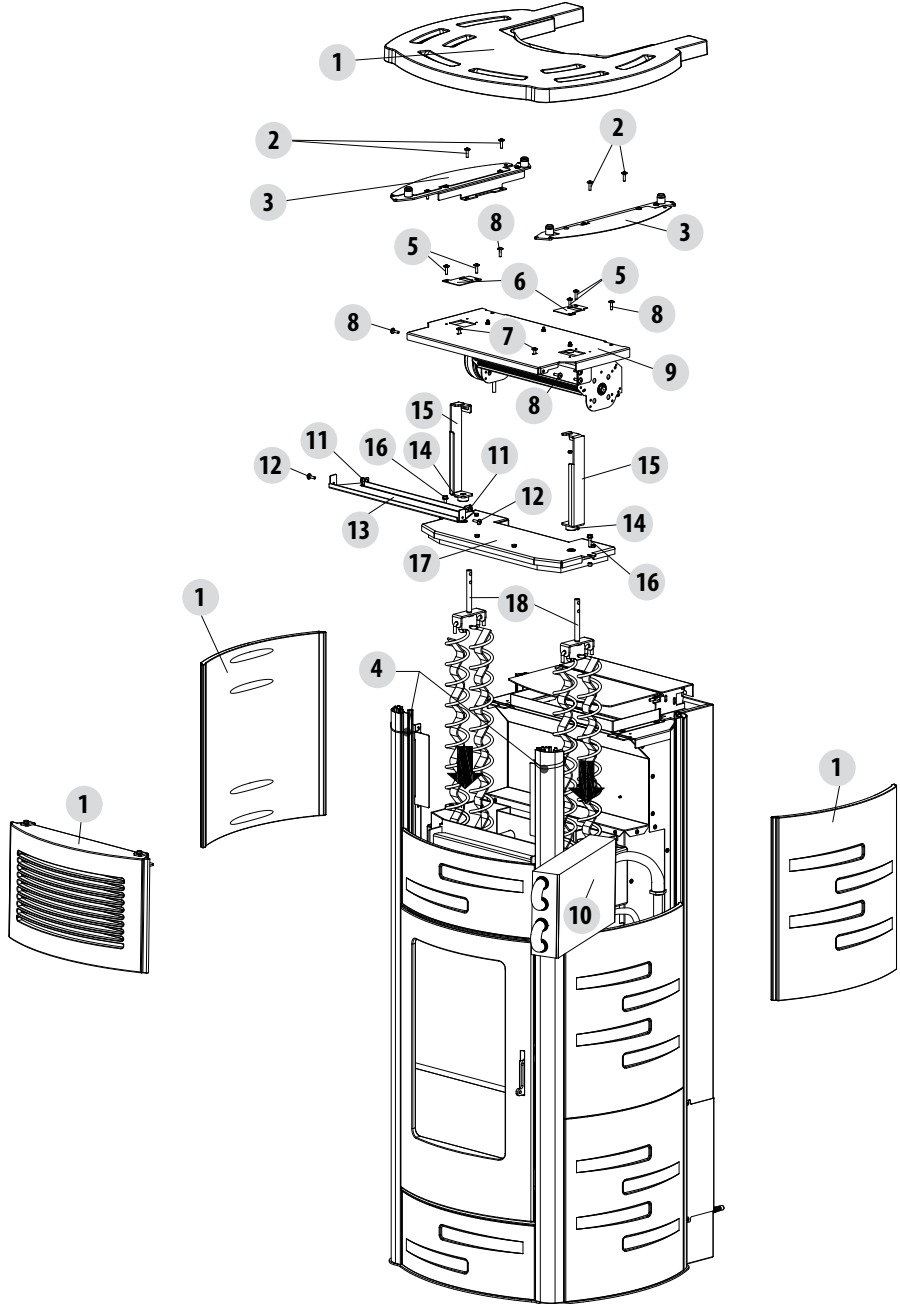

16-CLEANING AND MAINTENANCE

- Remove the top "1"
- Remove the 4 screws "2"
- Remove the two profile supports "3"



To avoid removing the entire cladding, block the two front profiles with two clamps "4".

- Remove the four screws "5" and as a result remove the two plates of the turbulator rods "6"
- Loosen the two screws "7", remove the two screws "8" and remove the entire fan block "9"
- Remove the exchanger "10"
- Loosen the two screws "11", remove the two screws "12" and remove the exchanger support "13"
- Loosen the two screws "14" and remove the rods "15"
- Remove the two screws with shims "16" and the stove cover "17"
- Remove the turbulators "18"

At this point, using a rod or a brush for cleaning bottles, clean inside the pipe unit and the pipes, removing any ash deposits. Check the cover seal "17" and replace it if necessary.



It is obligatory to have an authorised and skilled technician perform the periodic end-of-season cleaning in order to replace any worn gaskets.

CLEANING THE SMOKE EXHAUST SYSTEM AND GENERAL CHECKS

Clean the smoke extractor system, especially around the "T" joints, elbows and any horizontal sections of the smoke duct. For information on periodically cleaning the flue, contact a skilled chimney sweep.

Check the seal of the ceramic fibre gaskets on the door of the stove. If necessary, order new replacement seals from the retailer or contact an authorized service centre to carry out this task.



CAUTION:

The frequency with which the smoke outlet system is cleaned depends on the use of the boiler and the type of installation.

We recommend relying on an authorised service centre for end-of-season cleaning and maintenance, as they will carry out all of the previously mentioned work and inspect the stove components.

SHUTDOWN (end of season)

At the end of each season, before switching the product off, it is recommended to remove all the pellets from the hopper with a vacuum cleaner with a long pipe.

When not in use the appliance must be disconnected from the mains power supply. It is recommended to remove the power cable for additional safety, especially in the presence of children.

The service fuse may have to be replaced if the control panel display does not switch on when the product is switched on again by pressing the main switch on its side.

There is a fuse compartment on the back of the product, under the power socket. After having disconnected the plug from the socket, use a screwdriver to open the cover of the fuse compartment and if necessary, replace them (3.15 A delayed).

16-CLEANING AND MAINTENANCE

REPLACEMENT OF OVERPRESSURE SILICON DAMPER FOR COMBUSTION CHAMBER

The overpressures silicon damper "G" for combustion chamber (fig. A) shall be replaced with a new one yearly (during the periodical maintenance) in order to keep the overpressure safety system efficient.

For replacement use the following instructions

- remove the top
- remove the first lateral ceramic covering / metal covering (in accordance with the model)
- unscrew the screw-washer-damper-spacer shown in fig. A/C (operate same way on both sides)

Install the new kit as follows:

- Prepare the screw-washer-damper-spacer aligned as shown in fig.C and screw them in the structure.
- screw it completely

Check now the proper compression of dampers, using the gauge included in the kit:

- lay the gauge on the lid (fig.B); the gauge has to lay completely, while the head of the screw has to be in contact with the gauge. If it's not the case, register the screw accordingly.

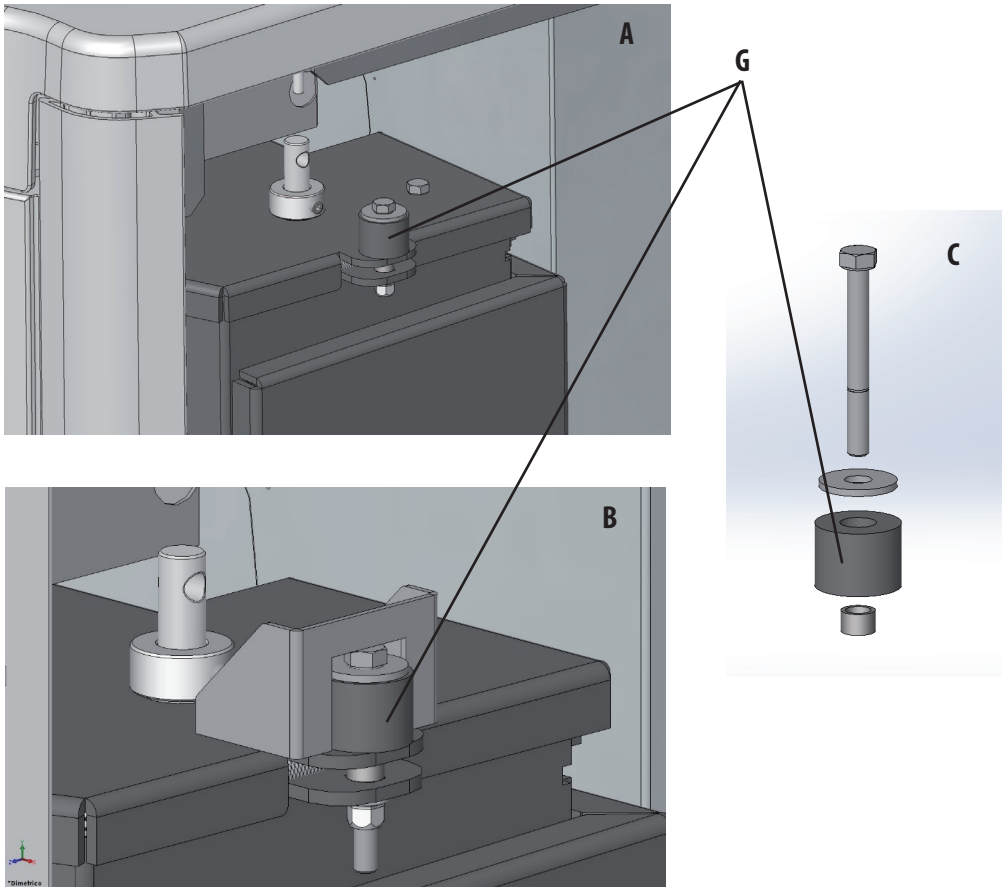

16-CLEANING AND MAINTENANCE

CHECKING THE INTERNAL COMPONENTS



ATTENTION!

The internal electromechanical components must only be checked by qualified personnel whose technical expertise includes combustion and electricity.

We recommend that an annual maintenance service is carried out (with a scheduled service contract). This service is essentially a visual and functional inspection of the internal components. The following is a summary of the checks and/or maintenance that are essential for the correct operation of the product.

PARTS/INTERVAL	EVERY DAY	EVERY WEEK	15 DAYS	EVERY SEASON
Brazier*	•			
Ash pan	•			
Glass		•		
Lower compartment			•	
Complete exchanger				•
Smoke duct				•
Door gasket				•
Internal parts				•
Flue				•
Circulation pump				•
A plate heat exchanger				•
Plumbing components				•
Electro-mechanical components				•
Overpressure silicon damper for combustion chamber				•

* WITH POOR QUALITY PELLETS CLEANING FREQUENCY MUST BE INCREASED

CLEANING THE CONTROL PANEL DISPLAY



ATTENTION!!

THE PANEL DISPLAY IS VERY DELICATE, IT IS SUPPLIED WITH A PROTECTIVE FILM.

RECOMMENDATIONS FOR CLEANING:

Clean using a soft cotton cloth, dry or slightly moist.

Do not use aggressive detergents or polyester materials.

Do not use abrasive sponges or powder detergents nor solvents such as alcohol and petrol, since they may damage the surface of the device.

17-FAULTS/CAUSES/SOLUTIONS



CAUTION:

All repairs must be carried out exclusively by a specialised technician, with the stove completely cold and the electric plug pulled out.

ANOMALY	POSSIBLE CAUSES	SOLUTIONS
The pellets are not fed into the combustion chamber.	The pellet hopper is empty	Fill the hopper with pellets
	Sawdust has blocked the feed screw	Empty the hopper and remove the sawdust from the feed screw by hand
	Faulty gear motor	Replace the gear motor
	Faulty electronic board	Replace the circuit board
The fire goes out or the stove stops automatically	The pellet hopper is empty	Fill the hopper with pellets
	The pellets are not fed	See the previous anomaly
	The pellet temperature safety probe has been triggered	Let the stove cool down, reset the thermostat until the problem is resolved and switch the stove back on. If the problem persists contact Technical Assistance.
	Chrono active	Check if the chrono setting is active
	The door is not closed properly or the gaskets are worn	Close the door and replace the gaskets with original ones
	Unsuitable pellets	Change the type of pellets with those recommended by the manufacturer
	Low pellet supply	Check the flow of fuel following the instructions in the booklet.
	The combustion chamber is dirty	Clean the combustion chamber, following instructions in the manual
	Clogged outlet	Clean the smoke duct
	Faulty smoke extraction motor	Check the motor and replace it, if necessary
Water tank temperature too high	Check correct operation of the water circulation pump and the hydraulic system in general.	

17-FAULTS/CAUSES/SOLUTIONS

ANOMALY	POSSIBLE CAUSES	SOLUTIONS
The stove runs for a few minutes and then goes out	Start-up phase is not completed	Repeat start-up
	Temporary power cut	Wait for the automatic restart
	Clogged smoke duct	Clean the smoke duct
	Faulty or malfunctioning temperature probes	Check and replace the probes
Pellets accumulate in the brazier, the glass of the door gets dirty and the flame is weak	Insufficient combustion air	Make sure that the air inlet in the room is fitted and clear. Check that the combustion air filter on the Ø 5 cm air inlet pipe is not clogged. Clean the brazier and check that all the holes are clear. Perform a general cleaning of the combustion chamber and the smoke duct. Check the condition of the door gaskets
	Damp or unsuitable pellets	Change the type of pellets
	Faulty smoke evacuation motor	Check the motor and replace it, if necessary
The smoke evacuation motor does not work	No electrical supply to the stove	Check the mains voltage and the protection fuse
	Motor block caused by clogging.	Perform a general cleaning of the combustion chamber and the smoke duct.
	The motor is faulty	Check the motor and capacitor and replace them, if necessary
	Defective motherboard	Replace the electronic board
	Control panel broken	Replace the control panel
The stove does not run	No power supply	Check that the plug is inserted and the main switch is in the "I" position
	Pellet or water probe fault	Wait for the pellet or water tank to cool down and restart the stove
	Blown fuse	Replace the fuse
	Faulty spark plug	Check the spark plug and replace it, if necessary

17-FAULTS/CAUSES/SOLUTIONS

ANOMALIES RELATED TO THE HYDRAULIC CIRCUIT

ANOMALY	POSSIBLE CAUSES	SOLUTIONS
No increase in temperature with stove in operation	Incorrect combustion adjustment	Check recipe
	Boiler / system dirty.	Check and clean the boiler
	Insufficient stove power	Check that the stove is properly sized for the requirements of the system
	Poor pellet quality	Use pellets from the producer
Condensation in boiler	Incorrect boiler or pump temperature setting	Set the stove or the pump to a higher temperature
	Insufficient fuel consumption	Check recipe
Radiators cold in winter	Room thermostat (local or remote) set too low. If remote thermostat, check if it is defective.	Set to higher temperature or replace. (if remote)
	Circulator does not run because it is blocked	Free up the circulator by removing the plug and turning the shaft with a screwdriver
	Circulator does not run	Check the electrical connections of the circulator; replace if necessary
	Radiators have air in them	Vent the radiators
Hot water is not provided	Circulator (pump) blocked	Free the circulator (pump)



If the stove is NOT used as described in this instruction booklet, the manufacturer refuses to accept any responsibility for damage to persons and property that may arise. The manufacturer furthermore refuses to accept responsibility for damage to persons and property arising from the failure to observe all the rules contained in the manual and in particular:

- ***The operations in italics must be carried out by specialised personnel from the manufacturer***
- ***All the necessary measures and/or precautions must be adopted when performing maintenance, cleaning and repairs.***
- ***Do not tamper with the safety devices.***
- ***Do not remove the safety devices.***
- ***Connect the stove to an efficient smoke extraction system.***
- ***First, check that the environment where it is to be installed is properly ventilated.***

18-CIRCUIT BOARD

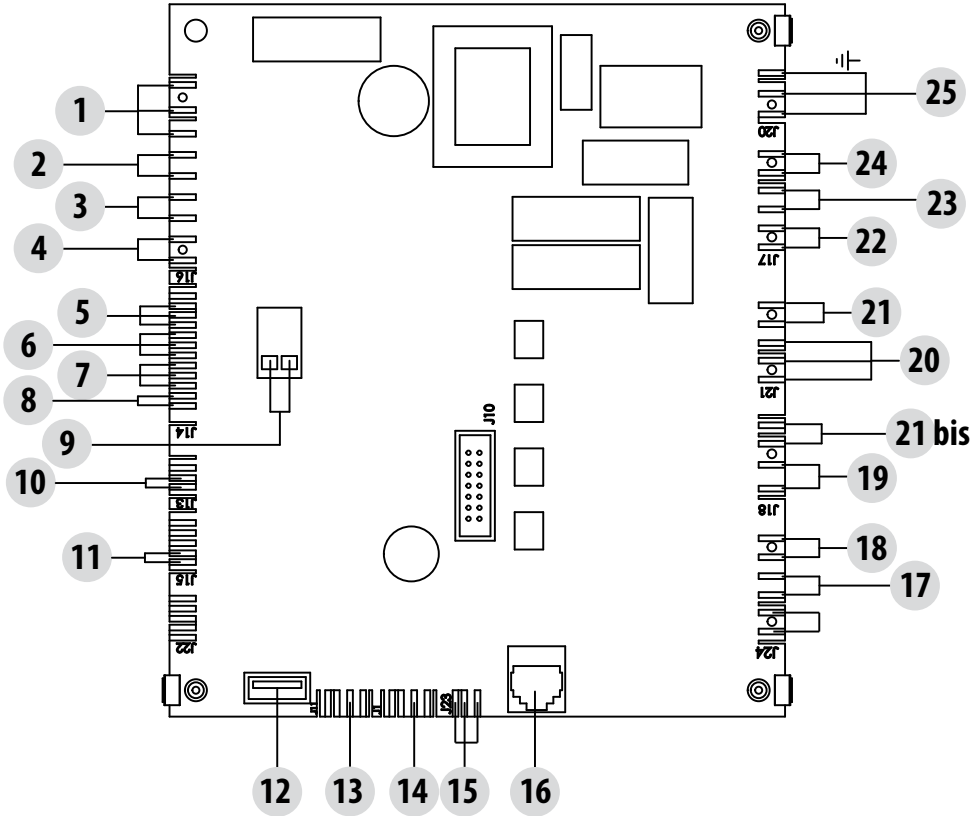

MOTHERBOARD WIRING KEY

- | | |
|------------------------------------|--|
| 1. AUX RELAY (C-NO-NC) | 14. SERIAL COMMUNICATION |
| 2. HOME AUTOMATION CONTACT | 15. PWM PUMP CONTROL |
| 3. ROOM PROBE | 16. CONTROL PANEL |
| 4. INPUT AUX | 17. WATER TEMPERATURE OVERLOAD CUT-OUT |
| 5. SMOKE FAN ENCODER | 18. HOPPER OVERLOAD CUT-OUT |
| 6. GEAR MOTOR ENCODER | 19. AIR FAN |
| 7. PRESSURE TRANSDUCER | 20. 3-WAY VALVE |
| 8. WATER PROBE | 21. PWM PUMP SUPPLY |
| 9. SMOKE TEMPERATURE PROBE | 21bis. STANDARD PUMP |
| 10. PELLET LEVEL SENSOR (OPTIONAL) | 22. GEAR MOTOR |
| 11. AIR FAN PROBE | 23. SMOKE FAN |
| 12. SOFTWARE UPDATE | 24. SPARK PLUG |
| 13. EXPANSION | 25. SWITCH |

N.B. The wiring of the individual components is fitted with pre-wired connectors of different sizes.



Via La Croce n°8
33074 Vigonovo di Fontanafredda (PN) – ITALY
Telephone: +39 0434/599599 r.a.
Fax: 0434/599598
Internet: www.mcz.it
www.mcz.it e-mail: info.red@mcz.it